



## OpenTouch® Suite for MLE

8078s	Bluetooth® Premium DeskPhone
8078s	Premium DeskPhone
8068s	Bluetooth® Premium DeskPhone
8068s	Premium DeskPhone
8058s	Premium DeskPhone
8028s	Premium DeskPhone
8018	DeskPhone
8008G	DeskPhone
8008	DeskPhone

### User Manual

8AL90339ENADed02-2102

## Introduction

Thank you for choosing an Alcatel-Lucent Enterprise Desk Phone.



This document describes the services offered by the 8000 range desk phones in connection with an OmniPCX Enterprise system.

The 8000 range is composed by the following desk phones:

- 8078s Bluetooth® Premium DeskPhone (8078s BT).
- 8078s Premium DeskPhone (8078s).
- 8068s Bluetooth® Premium DeskPhone (8068s BT).
- 8068s Premium DeskPhone (8068s).
- 8058s Premium DeskPhone (8058s).
- 8028s Premium DeskPhone (8028s).
- 8018 DeskPhone (8018).
- 8008G DeskPhone (8008G).
- 8008 DeskPhone (8008).

These models offer enhanced ergonomic features for more effective communication.

Your phone can be used in any business environment, from on-premise PBX, to cloud deployment on multiple platforms, such as Alcatel-Lucent Enterprise servers or third-party SIP telephony platforms.

The labels and icons displayed depend on the type and the skin of the set. The label is not displayed if the corresponding feature is not configured on your telephone system. Depending on the size of the display, some labels may be truncated. *All labels are displayed in color and are italicized.* This icon describes a succession of actions or labels you have to do or select: **➤**.

This icon describes the consequence of an action: **➤➤**.

Available features depend on the software version and the phone model. Please contact your system administrator to determine the features available on your system.

	8078s BT	8078s	8068s BT	8068s	8058s	8028s	8018	8008G	8008
IP Phone	●	●	●	●	●	●	●	●	●
Color screen	●	●	●	●	●				
Monochrome screen						●	●	●	●
Busy light logo on back shell	●	●	●	●	●				
Theme (skin)	●	●	●	●	●				
Adjusting the contrast of the display						●	●	●	●
Ambient light sensor	●	●	●	●	●				
Audio services (hands-free, headset and handset)	●	●	●	●	●	●	●	●	●
Symphonic HD	●	●	●	●	●				
Super Wide Band melodies	●	●	●	●	●				
USB audiohub	●	●	●	●	●				
Bluetooth® audiohub	●	●	●	●					
Bluetooth® handset	●	(o)	●	(o)					
Super Wide Band Comfort handset	●	●	●	●	●	●	●		
Wide Band Comfort handset	●	●	●	●	●	●	●		
8008 Standard Handset								●	●
Bluetooth® Smart Ready	●	●	●	●					
Compatible with Bluetooth® headset	●	●	●	●					
USB headset	●	●	●	●	●	●	●		
Jack headset (3.5 mm, 4 pole)	●	●	●	●	●	●			
RJ9 headset*								●	●
Two-port Gigabit Ethernet switch with Power Over Ethernet support	●	●	●	●	●	●	●	●	
Two-port Fast Ethernet switch with Power Over Ethernet support									●
Premium Add-on 10 keys modules			●	●	●	●			
Premium Smart display 14 keys module	●	●	●	●	●	●			
Premium add-on 40-key modules	●	●	●	●	●	●			

\*Use an adapter RJ9 to connect a headset (3GV28177AA).

(o): optional.

The labels and icons presented in this document are not contractually binding and may be modified without prior warning.

## History of the document

8AL90339xxAD	<ul style="list-style-type: none"> <li>• Bluetooth® advanced features (beacon).</li> <li>• Visual Notification Assistant (VNA).</li> <li>• 8008G DeskPhone.</li> <li>• New ringtones and skins.</li> <li>• Synphonic HD.</li> <li>• USB audiohub.</li> <li>• Bluetooth® audiohub.</li> </ul>
8AL90339xxAC	<ul style="list-style-type: none"> <li>• 8008 DeskPhone.</li> <li>• New description of accessories: 8008 wall mount kit, USB external ringing interface module.</li> <li>• 8058s dual display mode.</li> </ul>
8AL90339xxAB	<ul style="list-style-type: none"> <li>• 8018 DeskPhone.</li> <li>• Add list and description of accessories: 8115/8125 Audiooffice, External ringing interface module, Premium Wall mount kit, 8018 wall mount kit.</li> <li>• Add technical specifications.</li> <li>• Add ordering information.</li> </ul>
8AL90339xxAA	<ul style="list-style-type: none"> <li>• 8078s,8068S,8058s,8028s Premium DeskPhone.</li> </ul>

1	Getting to know your telephone	11
1.1	8078s Bluetooth/ 8078s Premium DeskPhone	11
1.1.1	Phone description	11
1.1.2	Main screen and navigation keys	12
1.1.3	Call management screen	12
1.1.4	Access to the user local menu	13
1.1.5	Change the theme (skin) of your phone	13
1.1.6	Busy light logo on back shell	13
1.1.7	Bluetooth Smart Ready	13
1.2	8068s Bluetooth/ 8068s Premium DeskPhone	14
1.2.1	Phone description	14
1.2.2	Main screen and navigation keys	15
1.2.3	Call management screen	15
1.2.4	Access to the user local menu	16
1.2.5	Change the theme (skin) of your phone	16
1.2.6	Busy light logo on back shell	16
1.2.7	Bluetooth Smart Ready	16
1.3	8058s Premium DeskPhone	17
1.3.1	Phone description	17
1.3.2	Dual display mode	17
1.3.3	Main screen and navigation keys	18
1.3.4	Call management screen	18
1.3.5	Access to the user local menu	19
1.3.6	Change the theme (skin) of your phone	19
1.3.7	Busy light logo on back shell	19
1.4	8028s Premium DeskPhone	20
1.4.1	Phone description	20
1.4.2	Main screen and navigation keys	21
1.4.3	Call management screen	21
1.4.4	Access to the user local menu	22
1.4.5	Changing or updating the paper label	22
1.5	8018 DeskPhone	23
1.5.1	Phone description	23
1.5.2	Main screen and navigation keys	24
1.5.3	Call management screen	24
1.5.4	Changing or updating the paper label	25
1.5.5	Function keys and programmable keys	25
1.6	8008 / 8008G DeskPhone	26
1.6.1	Phone description	26
1.6.2	Main screen and navigation keys	27
1.6.3	Call management screen	27
1.6.4	Function keys and programmable keys	28
1.7	Symphonic HD (Super Wideband audio)	28
1.8	Welcome screens	29
1.8.1	Homepage description	29
1.8.2	Choose the page displayed by default on the telephone	29
1.9	User local menu	30
1.10	Status icons/ Call icons	32
1.11	Permanent features keys	33
1.12	Keyboard	34
1.12.1	Magnetic alphabetic keyboard (8078s, 8068s, 8058s, 8028s Premium DeskPhone)	34
1.12.2	Alpha-numeric keyboard (8008/8008G/8018 DeskPhone)	34
1.13	Connectors	35
1.14	Description of the connectors	35
1.14.1	Plug in the phone	36
1.14.2	USB boost	36

1.15	Add-on module	37
1.15.1	Install the add-on to the desk phone	37
1.15.2	Install more than one add-on module	38
1.15.3	Attach the add-on with the clip	38
1.15.4	Changing or updating the paper label	39
1.16	Next generation of Bluetooth® handsets (ALE Wideband Bluetooth® Handset)	40
1.16.1	Voice prompts	41
1.16.2	Installing or replacing the Bluetooth® handset battery	41
1.16.3	Pairing and connecting the Bluetooth® wireless handset	42
1.17	First generation Bluetooth® handset (ALE Bluetooth® Handset)	43
1.17.1	Installing or replacing the Bluetooth® handset battery	44
1.17.2	Pairing and connecting the Bluetooth® wireless handset	44
1.18	Comfort wired handset	45
1.18.1	Super Wide Band Comfort Handset	45
1.18.2	Wide Band Comfort Handset	45
1.18.3	Install a comfort wired handset	46
1.19	Audio encryption	46
2	Using your telephone	47
2.1	Identify the terminal you are on	47
2.2	Consulting the call log	47
2.2.1	Consulting all calls	47
2.2.2	Delete all call logs	47
2.3	Making a call	48
2.4	Receiving a call	48
2.5	Ignore the call	49
2.6	Switching between audio modes	49
2.7	Activating the loudspeaker during a conversation (handset lifted) - Group listening feature	50
2.8	Making calls by name (company directory)	50
2.9	Make calls via your programmed call keys (Perso page/F1 and F2 keys/Add-on module)	50
2.10	Redialing	51
2.10.1	Redialing the last number dialed (redial)	51
2.10.2	Call back one of the last 8 numbers dialed	51
2.11	Callback requests	51
2.12	Call back an unanswered call	51
2.12.1	Call back the last caller	51
2.12.2	List of last callers	52
2.12.3	Delete the list of unanswered calls	52
2.13	Requesting automatic callback if internal number is busy	52
2.14	Receiving interphony calls	52
2.15	Sending DTMF signals	53
2.16	Mute, so that your contact cannot hear you	53
2.16.1	From the set	53
2.16.2	From the Bluetooth® handset (Bluetooth® wireless handset)	53
2.16.3	From the headset	53
2.17	Forwarding calls to your voice message service	54
2.18	Consulting your voice mailbox	54
2.19	Sending a text message to an internal contact	54
2.20	Consulting text messages	55
2.21	Lock / unlock your telephone	55
2.22	Making a second call during a conversation	55
2.22.1	Other methods for calling a second contact	55
2.22.2	Release the second call and recover the call on hold	56
2.23	Answering a second call during a conversation	56
2.24	Switching between calls (Broker call)	56
2.25	Transferring a call	56
2.26	Three-way conference with internal and/or external contacts (conference)	57
2.26.1	Cancel conference and return to first contact (if conference is active)	57
2.26.2	Hang up on all participants (if conference is active)	57
2.26.3	After the conference, to leave your two contacts talking together	57

2.26.4	View information about the other people in the conference	57
2.27	Talk simultaneously to more than 2 contacts	57
2.28	Placing a call on hold (hold)	57
2.28.1	Exclusive hold	57
2.28.2	Common hold	58
2.29	Placing an outside call on hold (parking)	58
2.30	Intrusion into an internal conversation (barge-in)	58
2.30.1	Protect a call against intrusion	58
2.31	Signal malicious calls	59
2.32	Recording the current conversation	59
2.33	Forwarding calls to another number (immediate forward)	59
2.34	Forwarding calls if you do not answer or if you are busy	59
2.35	Do not disturb	60
2.36	Forwarding calls to your pager	60
2.37	Forwarding your calls from the receiving terminal ('Follow me')	60
2.38	Applying a selective forward	60
2.39	Cancelling all forwards	61
2.40	Leaving a text message for internal callers	61
3	'Meet me' conference	62
3.1	Initiate a 'Meet me' conference	62
3.2	Join a 'Meet me' conference	62
4	Sharing	63
4.1	Answering the general bell	63
4.2	Manager/Assistant filtering	63
4.3	Call pick-up	63
4.4	Hunting groups	64
4.5	Calling an internal contact on his/her pager	64
4.6	Answering a call on your pager	64
4.7	Calling a contact on his/her loudspeaker	65
4.8	Broadcasting a message on the loudspeakers of a station group	65
5	Managing your charges	66
5.1	Charging your calls directly to business accounts	66
5.2	Finding out the cost of an outside call made for an internal user from your terminal	66
6	Do more with your desk phone	67
6.1	Use your desk phone as a USB audiohub for your computer	67
6.1.1	Installation	68
6.1.2	Use your desk phone as an audiohub (hands-free mode, handset and headset)	70
6.1.3	Use your desk phone to listen to music	72
6.2	Use your desk phone as a Bluetooth® audiohub with your mobile phone (hands-free mode, handset and headset)	73
6.2.1	Pair and connect your mobile phone to your desk phone	73
6.2.2	Automatic reconnection of your mobile	74
6.2.3	Define the specific ringing for incoming calls	74
6.2.4	Meeting room	74
6.2.5	Consult the call log of your mobile phone	75
6.2.6	Consult the contacts directory of your mobile phone	75
6.2.7	Making a call	75
6.2.8	Receiving a call	76
6.2.9	During conversation	76
6.2.10	Switching between audio modes	77
6.2.11	Release the call	78
6.3	Configure your phone for remote working	79
6.3.1	First connection as remote working	79
6.3.2	Change the configuration	80
6.3.3	PIN code	81
6.3.4	Reset your PIN code	81
6.3.5	Reconnect your desk phone in your business place	81

6.3.6	Reconnect your desk phone in remote place	82
6.4	Beacon: using your desk phone for geo-localization in the enterprise	83
6.5	Visual Notification Assistant (VNA)	84
6.6	EHS (Electronic Hook Switch)	85
7	Programming your telephone	86
7.1	Initializing your voice mailbox	86
7.2	Customizing your voice greeting	86
7.3	Modify the password for your phone set	86
7.4	Modify the password for your voice mailbox	87
7.5	Adjusting the audio functions	87
7.5.1	Choose the tune	87
7.5.2	Adjusting the ringer volume	87
7.5.3	Activate/deactivate silent mode	87
7.5.4	Activate/deactivate meeting mode (progressive ringing)	88
7.5.5	Activate/deactivate discreet ring mode	88
7.5.6	Adjust ringer volume while a call arrives	88
7.6	Audio ambiences	88
7.7	Hearing Aid	88
7.8	Adjusting the brightness of the desk phone (8078s, 8068s, 8058s, 8028s Premium DeskPhone)	89
7.8.1	Auto-adjusting of the brightness	89
7.8.2	Adjust the brightness when the phone is in use	89
7.8.3	Adjust the dimmed brightness when the phone is not in use	89
7.8.4	Set the delay before the brightness is dimmed when the phone is not in use (screensaver)	89
7.9	Adjusting the contrast of the display (8028s, 8018, 8008G, 8008)	90
7.10	Selecting the welcome page	90
7.11	Selecting language	90
7.12	Programming keys for call numbers and functions (Perso page/F1 and F2 keys/Add-on keys)	90
7.12.1	Other possibilities	91
7.13	Modify a programmed key	91
7.14	Delete a programmed key	91
7.15	Programming an appointment reminder	92
7.16	Call the associated set	92
7.17	Forward your calls to the associated number	92
7.18	Modify the associated number	93
7.19	The Tandem configuration	93
7.20	Create, modify or consult your interphony list (max. 10 numbers)	93
7.21	Install a jack accessory (headset, hands-free, loudspeaker) (8078s, 8068s, 8058s, 8028s Premium DeskPhone)	93
7.21.1	Install the accessory	93
7.21.2	Activate the ringing into the device	94
7.21.3	Use a device compatible with Android mobile	94
7.21.4	Use a wireless DECT headset connected to the jack connector	94
7.22	Install a USB accessory (Headset, Handsfree, Loudspeaker)	95
7.23	Install a RJ9 headset (8008G/8008 DeskPhone)	95
7.24	Manage connected devices	95
7.24.1	List of connected devices	95
7.24.2	Default device	96
7.25	Installing and using an ALE Bluetooth® wireless handset	96
7.26	Installing a Bluetooth® Wireless Technology headset (pairing)	96
7.27	Using a Bluetooth® Wireless Technology headset	97
7.28	Display all paired Bluetooth® devices	97
7.29	Improve the Bluetooth® audio quality in a high Wi-Fi density environment	97
7.30	Removing a Bluetooth® accessory (headset, handset, etc.)	97



8	Contacting your administrator (Technical support)	98
8.1.1	Technical code / Date code	98
8.1.2	Software version	98
8.2	Hardware model	98
8.3	Phone auto test	99
8.4	Access to administrator configuration	99
9	ACD: Agent set/ Supervisor station	100
9.1	Agent set	100
9.2	Open an agent session (LogOn) – Agent set	100
9.2.1	For a decision maker agent	100
9.3	ACD application welcome screen – Agent set	100
9.4	Close an agent session (LogOff)	101
9.5	Supervisor station	101
9.6	Open a supervisor session (LogOn)	101
9.7	Processing group- Supervisor entry/withdrawal	101
9.8	Supervision or acceptance of an assistance request	102
9.9	Close a supervisor session	102
10	Use the telephone in SIP survivability ('safe' mode)	103
10.1	Making a call	103
10.1.1	Take the line	103
10.1.2	Call by dialing internal number of your contact	103
10.1.3	Call using your contact's URI	103
10.2	Make a call using the personal phone book	103
10.3	Redialing the last number dialed	104
10.4	Receiving a call	104
10.4.1	Stop the ringer	104
10.4.2	Reject the call displayed	104
10.4.3	Answer the call	104
10.5	Making a second call during a conversation	104
10.5.1	To cancel your second call and recover the first	105
10.6	Answering a second call during a conversation	105
10.7	Placing a call on hold (hold)	105
10.8	Switching between calls (Broker call)	106
10.9	Transferring a call	106
10.10	Three-way conference with internal and/or external contacts (conference)	106
10.10.1	Hang up on all participants (If conference is active)	106
10.10.2	After the conference, to leave your two contacts talking together	106
10.11	Mute, so that your contact cannot hear you	106
10.12	Adjust audio volume	107
10.13	Forwarding calls to another number (immediate forward)	107
10.13.1	Modify the forwarding	107
10.13.2	Cancel the forwarding	107
10.14	Adjusting the audio functions	107
10.14.1	Choose the tune	107
10.14.2	Adjusting the ringer volume	107
10.14.3	Activate/deactivate silent mode / Activate/deactivate meeting mode (progressive ringing)	108
10.14.4	Activate/deactivate discreet ring mode	108
10.14.5	Adjust ringer volume while a call arrives	108
10.15	Selecting language	108
10.16	Sending DTMF signals	108

---

11	Accessories	109
11.1	List of accessories	109
11.1.1	Jack 3.5 mm 4-pole corded headset (ALE catalog)	109
11.1.2	USB headset	109
11.1.3	Bluetooth® headset	109
11.1.4	Adapter	109
11.1.5	EHS interface	109
11.1.6	USB Dongle	109
11.1.7	Other headsets	109
11.2	USB external ringing interface module (USB Interface module 2 relays 3GV28184AA)	110
11.2.1	Installation	110
11.2.2	Connect the device	111
11.3	External ringing interface module (MWS 3GV28050AA) - phased-out	112
11.3.1	List of supplies	112
11.3.2	Installation	112
11.3.3	Connect the device	113
11.4	Wall mounting kit	114
11.4.1	8068s, 8058s, 8028s Premium DeskPhone	114
11.4.2	8018 DeskPhone	115
11.4.3	8008/8008G DeskPhone	116
11.5	Connect a 3 pole jack headset	117
11.6	Developer and Solution Partner Program (DSPP)	118
12	Technical specifications	119
13	Ordering information	122
14	Guarantee and clauses	123
14.1	Safety Instructions	123
14.2	Regulatory Statements	124
	Quick guide	125

---

# 1 Getting to know your telephone

## 1.1 8078s Bluetooth/ 8078s Premium DeskPhone

This phone is part of the IP phone range. With its 5 inch color touch display, the 8078s Premium DeskPhone delivers a great user experience and great conversation comfort with an outstanding super wideband audio quality (HD audio) either in hands-free or using the Super Wide Band Comfort handset. Additionally, the 8078s Bluetooth® Premium DeskPhone improves your experience with its Bluetooth® handset or other Bluetooth® accessories. The 8078s Bluetooth® Premium DeskPhone is 'Bluetooth® Smart Ready'. You can personalize the phone by selecting a theme (skin). It is compatible with remote working. Consequently, it is perfect for use in your Enterprise office or in Home working.

### 1.1.1 Phone description



- 1 LED  
Flashing blue: incoming call / appointment alarm.
- 2 Color touchscreen display with auto brightness adjustment which improves the user experience and achieves power savings (ambient light sensor).
- 3 Permanent feature keys: quick access to the phone's main features.  
Your phone can be equipped with one of the following handsets:
  - Bluetooth® wireless handset (8078s BT).
  - Wired handset (Wide Band Comfort Handset / Super Wide Band Comfort Handset).
- 5 3.5 mm, 4 pole jack (TRRS standards: CTIA).
- 6 Magnetic alphabetic keyboard.
- 7 An adjustable and stable foot.
- 8 Super wideband loudspeaker for optimized sound.

### 1.1.2 Main screen and navigation keys

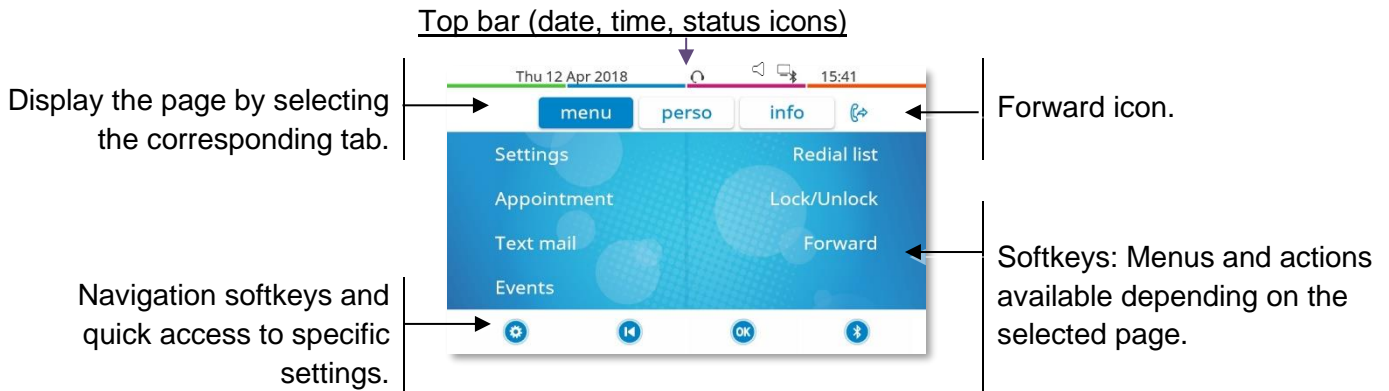

- Select a page by pressing the corresponding tab on the screen. The selected page is highlighted. Make your selection by pressing the label on the screen.
- Scroll a list (features, call log, contact, ...) by pressing the up and down arrow on the screen, or on the keyboard.
- Manage your call forwarding by pressing the forward icon.
  - Stationary arrow: no forwarding activated.
  - Blinking or rotating arrow according to the skin: forwarding activated.
- Use the 'OK' softkey to validate your choices and options while programming or configuring.
- Use the 'Back/Exit' softkey to go back to the previous step.
- Use the 'Setting' softkey for quick access to the user local menu.
- Use the 'Bluetooth®' softkey to open Bluetooth® settings.

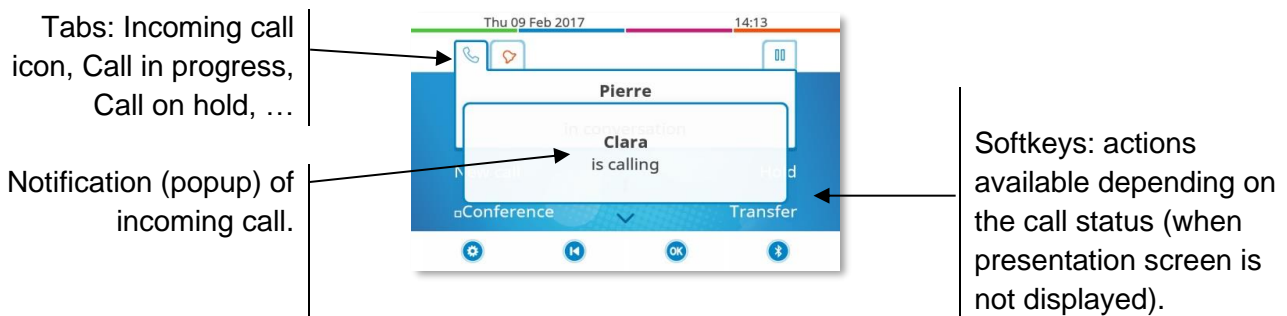

### 1.1.3 Call management screen



- Each tab corresponds to a call, the status of which is symbolized by its icon (in progress, call on hold, arrival of new call). When a call is in progress, press on the corresponding tab to look at calls on hold or incoming calls.
- All features are accessible while the call is displayed on the screen. Use the Up and Down arrows to move up or down a page. These functions (transfer, conference, etc.) are directly related to the status of the call consulted. For example, the transfer function will not be available between a call in progress or on hold and an incoming call.
- Use to switch to the main screen during conversation to access some functions, for example, searching by name.



Calls can also be managed from the Perso page. While the call is in progress, press the Back/Exit key and display the Perso page. Calls in progress or waiting calls are displayed on the different line keys. It is then possible to converse with the contact of your choice by pressing the key associated to the contact.

### 1.1.4 Access to the user local menu

 Or  (long press) › Open the user local menu: *Audiohub, Display, Bluetooth, Skin, About* (see: User local menu).

The User Local menu can also be accessed from the system MENU: Reach the 'Menu' page › *Settings* › *Phone* › *Local Menu*

### 1.1.5 Change the theme (skin) of your phone

- The phone is in idle state.
-  Or  (long press) › *Skin*
- Select the desired new theme from the list (Arcturus, Rainbow, Green, Luxury, Century). Some skins depend on the release of the phone (Century). The pictures are given as an example.



Changing the theme may take a few seconds. A corporate theme can be installed by your administrator. In this case, you cannot change the theme. The ringtone settings can be integrated into a theme.

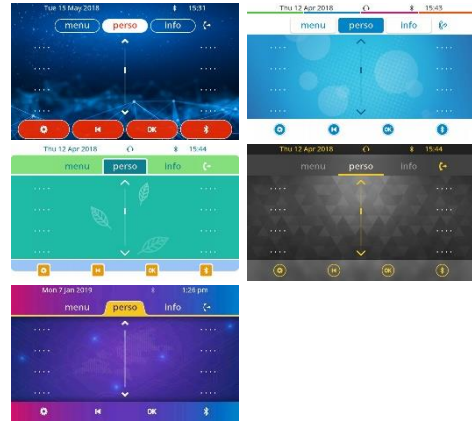

### 1.1.6 Busy light logo on back shell

The logo on back shell can be illuminated. The color changes when you are busy.

- The phone is in idle state.
-  Or  (long press) › *Display* › *Advanced* › *Busy light*
- Activate or deactivate the logo LED feature.
- 



### 1.1.7 Bluetooth Smart Ready



Your phone is 'Bluetooth® Smart Ready'. It can receive and share Bluetooth® signals from various Bluetooth® devices (Bluetooth® and Bluetooth® Smart or Low-energy devices). Use your phone as a Bluetooth® speaker phone, as a conferencing module in your desktop. It is ready for future services available on the fly in a subsequent software upgrade. This feature can be deactivated by the administrator.

## 1.2 8068s Bluetooth/ 8068s Premium DeskPhone

This phone is part of the IP phone range. With its color display that comes with ten dedicated function keys and an intuitive navigation key, the 8068s Premium DeskPhone delivers a great user experience and increased convenience with an outstanding super wideband audio quality (HD audio) in both hands-free mode and when using the Super Wide Band Comfort handset. Additionally, the 8068s Bluetooth® Premium DeskPhone improves your experience with its Bluetooth® handset or other Bluetooth® accessories. The 8068s Bluetooth® Premium DeskPhone is 'Bluetooth® Smart Ready'. You can personalize the phone by selecting a theme (skin). It is compatible with remote working. Consequently, it is perfect for use in your Enterprise office or in Home working.

### 1.2.1 Phone description



- 1** LED  
Flashing blue: incoming call / appointment alarm.
- 2** Color display with auto brightness adjustment which enhances user experience and saves power (ambient light sensor).
- 3** 10 dedicated functions keys.
- 4** Navigation.
- 5** Permanent feature keys: quick access to the phone's main features.  
Your phone can be equipped with one of the following handsets:
  - Bluetooth® wireless handset (8068s BT).
  - Wired handset (Wide Band Comfort Handset / Super Wide Band Comfort Handset).
- 6**
- 7** 3.5 mm, 4 pole jack (TRRS standards: CTIA).
- 8** Magnetic alphabetic keyboard.
- 9** An adjustable and stable foot.
- 10** Super wideband loudspeaker for optimized sound.

## 1.2.2 Main screen and navigation keys

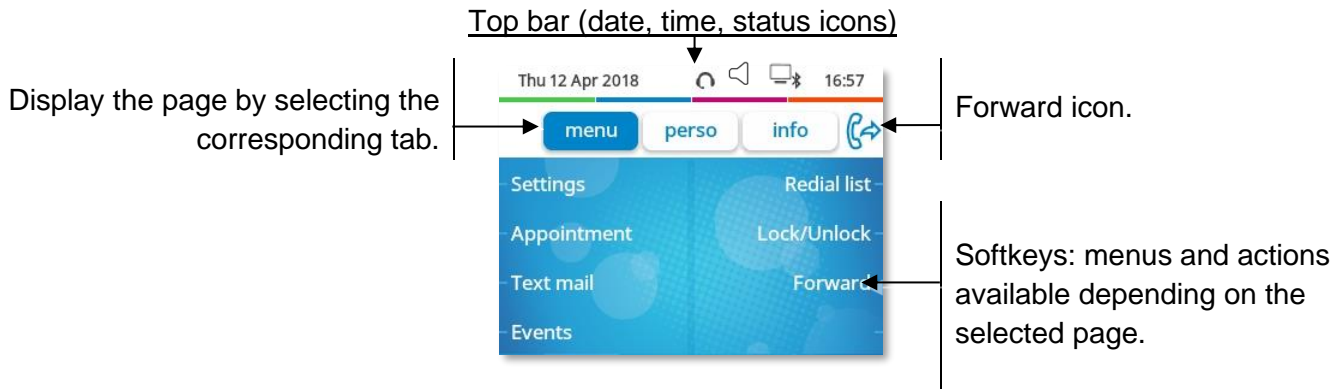

**OK key:** use this key to validate your choices and options while programming or configuring.

**Left-right navigator:** in idle state, use this key to move from one page to another. In conversation, use this key to move between tabs of current calls (call in progress, calls on hold, incoming call). In the text edition, use this key to navigate into the text box.

**Up-down navigator:** used to scroll through the content of a page.



**Back/Exit key:** use this key to go back to the previous step. Use this key to go back to the homepage (long press).



Manage your call forwarding by pressing the key associated with the forward icon.

- Stationary arrow: no forwarding activated.
- Blinking or rotating arrow according to the skin: forwarding activated.

## 1.2.3 Call management screen



Each tab corresponds to a call, the status of which is symbolized by its icon (in progress, call on hold, arrival of new call). When a call is in progress, use the left-right navigator to look at calls on hold or incoming calls.



All features are accessible while the call is displayed on the screen. Use the Up and Down arrows to move up or down a page. These functions (transfer, conference, etc.) are directly related to the status of the call consulted. For example, the transfer function will not be available between a call in progress or on hold and an incoming call.



Use to switch to the main screen during conversation to access some functions, for example, searching by name.



Press the key in front of the label to select the corresponding feature.

Calls can also be managed from the Perso page.



While the call is in progress, press the Back/Exit key and display the Perso page. Calls in progress or waiting calls are displayed on the different line keys. It is then possible to converse with the contact of your choice by pressing the key associated to the contact.

### 1.2.4 Access to the user local menu

 (long press) › Open the user local menu: *Audiohub, Display, Bluetooth, Skin, About* (see: User local menu).

The User Local menu can also be accessed from the system MENU: Reach the 'Menu' page › *Settings* › *Phone* › *Local Menu*

### 1.2.5 Change the theme (skin) of your phone

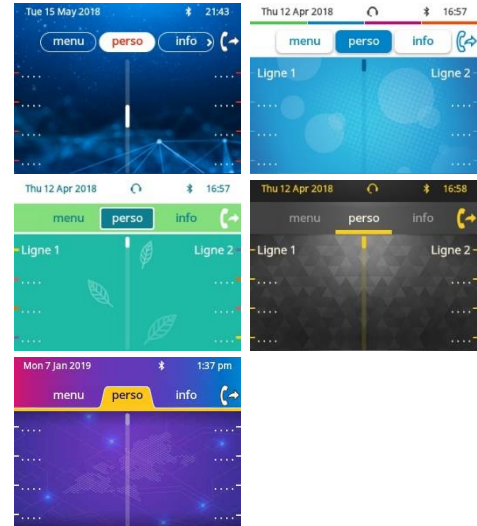

- The phone is in idle state.
-  (long press) › *Skin*
- Select the desired new theme from the list (Arcturus, Rainbow, Green, Luxury, Century). Some skins depend on the release of the phone (Century). The pictures are given as an example.
- 

Changing the theme may take a few seconds. A corporate theme can be installed by your administrator. In this case, you cannot change the theme. The ringtone settings can be integrated into a theme.



### 1.2.6 Busy light logo on back shell

The logo on back shell can be illuminated. The color changes when you are busy.

- The phone is in idle state.
-  (long press) › *Display* › *Advanced* › *Busy light*
- Activate or deactivate the logo LED feature.
- 



### 1.2.7 Bluetooth Smart Ready



Your phone is 'Bluetooth® Smart Ready'. It can receive and share Bluetooth® signals from various Bluetooth® devices (Bluetooth® and Bluetooth® Smart or Low-energy devices). Use your phone as a Bluetooth® speaker phone, as a conferencing module in your desktop. It is ready for future services available on the fly in a subsequent software upgrade. This feature can be deactivated by the administrator.



## 1.3 8058s Premium DeskPhone

This phone is part of the IP phone range. In addition to a color display associated to 6 dedicated function keys and an intuitive navigation key, the 8058s Premium DeskPhone provides 4 programmable softkeys as a smart add-on module, for a quick access to your favorite contacts or features. It provides a super wideband audio quality (HD audio) for telephone calls both in hands-free mode and using the comfort handset. You can personalize the phone by selecting a theme (skin). It is compatible with remote working. Consequently, it is perfect for use in your Enterprise office or in Home working.

### 1.3.1 Phone description



- 1 LED  
Flashing blue: incoming call / appointment alarm.  
Color display with auto brightness adjustment which enhances user experience and saves power (ambient light sensor).
- 2
- 3 6 dedicated functions keys.
- 4 Virtual add-on: 4 programmable softkeys with LED (Optional).
- 5 Navigation.
- 6 Permanent feature keys: quick access to the phone's main features.
- 7 Wired handset (Wide Band Comfort Handset / Super Wide Band Comfort Handset).
- 8 3.5 mm, 4 pole jack (TRRS standards: CTIA).
- 9 Magnetic alphabetic keyboard.
- 10 An adjustable and stable foot.
- 11 Super wideband loudspeaker for optimized sound.

The virtual add-on is optional and depends on the display mode defined by your administrator. Contact your administrator for more information.

### 1.3.2 Dual display mode

The 8058s Premium DeskPhone offers a dual display mode. Your administrator defines the display mode of your desk phone. Contact your administrator for more information.



User interface with virtual add-on. 4 programmable softkeys are displayed and can be used as a smart add-on module.



User interface without virtual add-on.

### 1.3.3 Main screen and navigation keys

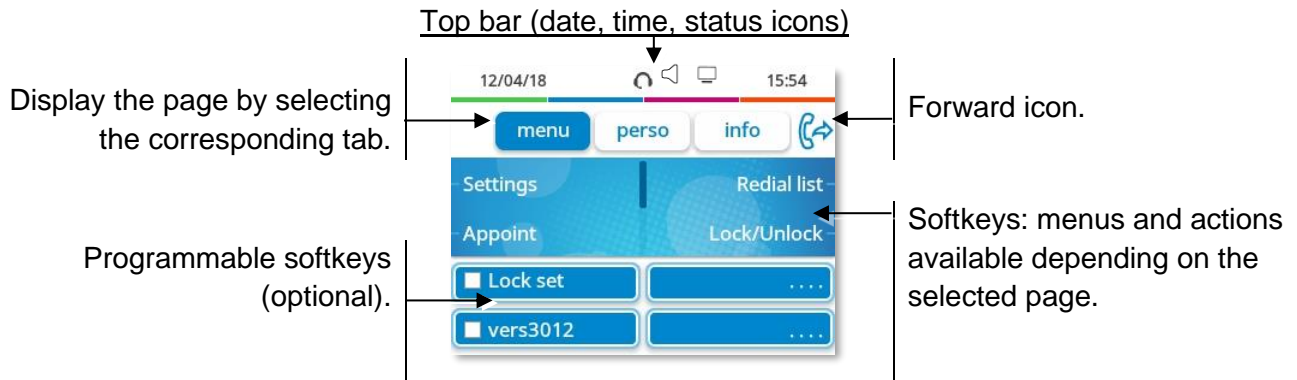

**OK key:** use this key to validate your choices and options while programming or configuring.  
**Left-right navigator:** in idle state, use this key to move from one page to another. In conversation, use this key to move between tabs of current calls (call in progress, calls on hold, incoming call). In the text edition, use this key to navigate into the text box.  
**Up-down navigator:** used to scroll through the content of a page.



**Back/Exit key:** use this key to go back to the previous step. Use this key to go back to the homepage (long press).



Manage your call forwarding by pressing the key associated with the forward icon.

- Stationary arrow: no forwarding activated.
- Blinking or rotating arrow according to the skin: forwarding activated.

### 1.3.4 Call management screen

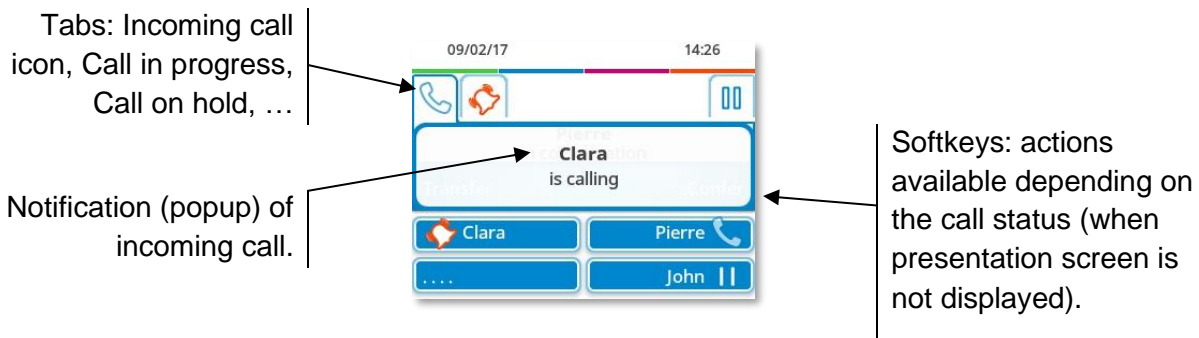

Each tab corresponds to a call, the status of which is symbolized by its icon (in progress, call on hold, arrival of new call). When a call is in progress, use the left-right navigator to look at calls on hold or incoming calls.



All features are accessible while the call is displayed on the screen. Use the Up and Down arrows to move up or down a page. These functions (transfer, conference, etc.) are directly related to the status of the call consulted. For example, the transfer function will not be available between a call in progress or on hold and an incoming call.



Use to switch to the main screen during conversation to access some functions, for example, searching by name.



Press the key in front of the label to select the corresponding feature.

Calls can also be managed from the Perso page.



While the call is in progress, press the Back/Exit key and display the Perso page. Calls in progress or waiting calls are displayed on the different line keys. It is then possible to converse with the contact of your choice by pressing the key associated to the contact.

### 1.3.5 Access to the user local menu

 (long press) › Open the user local menu: *Audiohub, Display, Skin, About* (see: User local menu).

The User Local menu can also be accessed from the system MENU: Reach the 'Menu' page › *Settings* › *Phone* › *Local Menu*

### 1.3.6 Change the theme (skin) of your phone

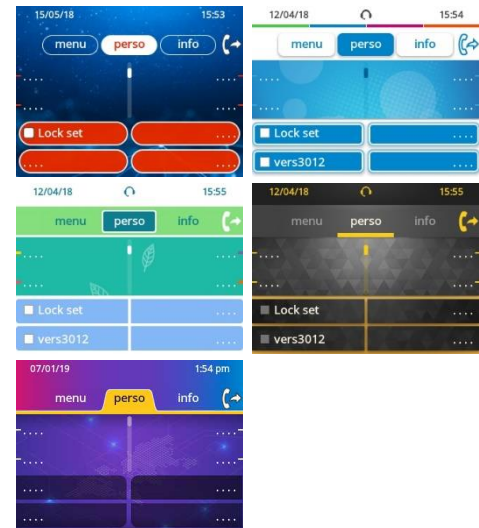

- The phone is in idle state.
-  (long press) › *Skin*
- Select the desired new theme from the list Arcturus, Rainbow, Green, Luxury, Century. Some skins depend on the release of the phone (Century). The pictures are given as an example.
- 

Changing the theme may take a few seconds. A corporate theme can be installed by your administrator. In this case, you cannot change the theme. The ringtone settings can be integrated into a theme.



### 1.3.7 Busy light logo on back shell

The logo on back shell can be illuminated. The color changes when you are busy.

- The phone is in idle state.
-  (long press) › *Display* › *Advanced* › *Busy light*
- Activate or deactivate the logo LED feature.
- 



## 1.4 8028s Premium DeskPhone

This phone is part of the IP phone range. In addition to a clear monochrome display associated to 6 dedicated function keys and an intuitive navigation key, the 8028s Premium DeskPhone provides 4 programmable keys as a smart add-on module, for a quick access to your favorite contacts or features. It provides high audio fidelity for telephone calls either in hands-free mode or using the comfort handset. It is compatible with remote working. Consequently, it is perfect for use in your Enterprise office or in Home working.

### 1.4.1 Phone description



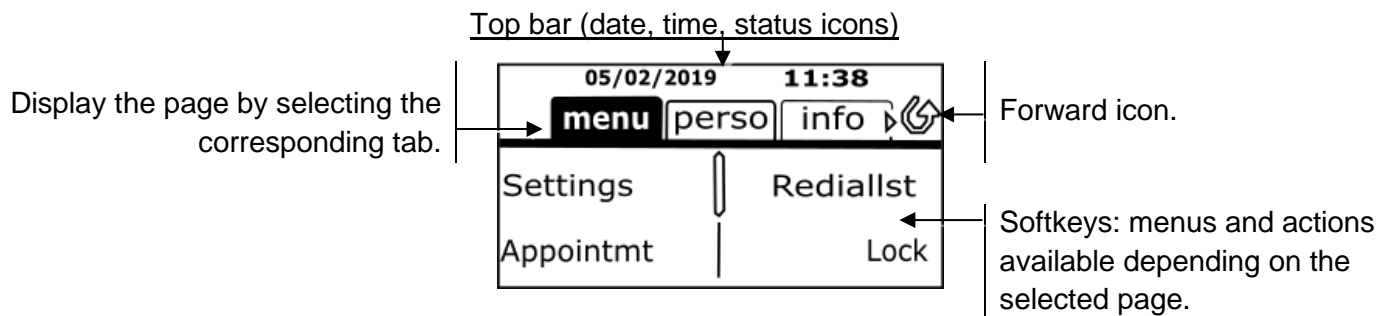

- 1 LED
- 1 Flashing blue: incoming call / appointment alarm.
- 2 Monochrome backlit screen.
- 3 6 dedicated functions keys.
- 4 4 programmable keys with Led and paper label.
- 5 Navigation.
- 6 Permanent feature keys: quick access to the phone's main features.
- 7 Wired handset (wide band audio quality).
- 8 3.5 mm, 4 pole jack (TRRS standards: CTIA).
- 9 Magnetic alphabetic keyboard.
- 10 An adjustable and stable foot.
- 11 Loudspeaker.

### 1.4.2 Main screen and navigation keys



- 



**OK key:** use this key to validate your choices and options while programming or configuring.
- 

**Left-right navigator:** in idle state, use this key to move from one page to another. In conversation, use this key to move between tabs of current calls (call in progress, calls on hold, incoming call). In the text edition, use this key to navigate into the text box.
- 

**Up-down navigator:** used to scroll through the content of a page.
- 

**Back/Exit key:** use this key to go back to the previous step. Use this key to go back to the homepage (long press).
- 

Manage your call forwarding by pressing the key associated with the forward icon.

  -  Stationary white icon: no forwarding activated.
  -  Rotating arrow: forwarding activated.

### 1.4.3 Call management screen

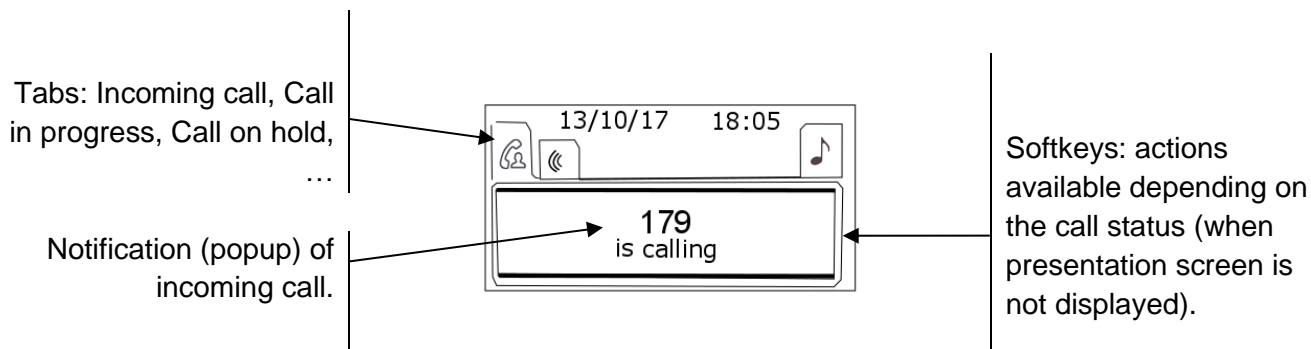

- 

Each tab corresponds to a call, the status of which is symbolized by its icon (in progress, call on hold, arrival of new call). When a call is in progress, use the left-right navigator to look at calls on hold or incoming calls.
- 

All features are accessible while the call is displayed on the screen. Use the Up and Down arrows to move up or down a page. These functions (transfer, conference, etc.) are directly related to the status of the call consulted. For example, the transfer function will not be available between a call in progress or on hold and an incoming call.
- 

Use to switch to the main screen during conversation to access some functions, for example, searching by name.
- 

Press the key in front of the label to select the corresponding feature.

Calls can also be managed from the Perso page. While the call is in progress, press the Back/Exit key and display the Perso page. Calls in progress or waiting calls are displayed on the different line keys. It is then possible to converse with the contact of your choice by pressing the key associated to the contact.

#### 1.4.4 Access to the user local menu

 (long press) › Open the user local menu: *Audiohub, Display* (see: User local menu).

The User Local menu can also be accessed from the system MENU: Reach the 'Menu' page › *Settings* › *Phone* › *Local Menu*

#### 1.4.5 Changing or updating the paper label

##### Removing the paper label

- Lift the protective cover at the notch (1).
- Remove the paper label in the same way (2).
- Update or replace the paper label.

##### Inserting the phone label

- Position the phone label, left side first, making sure it is placed correctly behind the notches (a,b,c,d).
- Put the protective cover back in the same way.

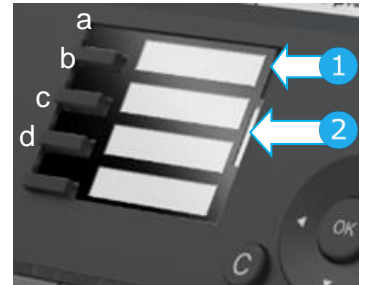

The application 'LabelSet' is available to help you to print the paper labels. Please contact your business partner for more information.

## 1.5 8018 DeskPhone

This phone is part of the IP phone range. In addition to a clear monochrome display associated to 6 dedicated function keys and an intuitive navigation key, the 8018 DeskPhone provides 4 programmable keys as a smart add-on module, for a quick access to your favorite contacts or features. It provides high audio fidelity for telephone calls either in hands-free mode or using the comfort handset. It is compatible with remote working. Consequently, it is perfect for use in your Enterprise office or in Home working.

### 1.5.1 Phone description





- 1 LED
- 1 Flashing blue: incoming call / appointment alarm.
- 2 Monochrome backlit screen.
- 3 6 dedicated functions keys.
- 3 3 preprogrammed keys with Led and paper icon: Alpha-numeric key, F1, F2.
- 4 4 programmable keys with Led and paper label.
- 5 Navigation.
- 6 Permanent feature keys: quick access to the phone's main features.
- 7 Wired handset (wide band audio quality).
- 8 USB connector for headset.
- 9 Stable foot
- 10 Loudspeaker.

Your phone has 4 programmable keys with led and paper label. These keys are used to program a direct call. You can use the paper to describe the key.

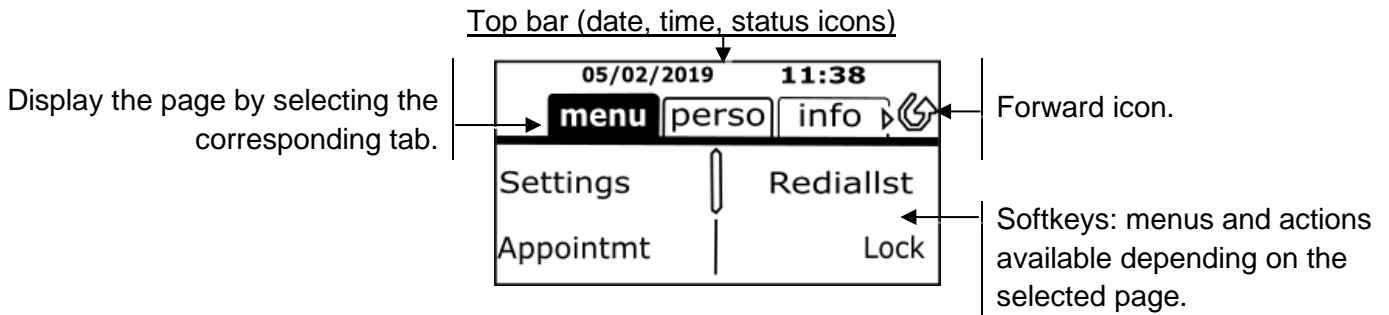
### 1.5.2 Main screen and navigation keys



- 

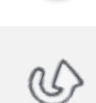

**OK key:** use this key to validate your choices and options while programming or configuring.
- 

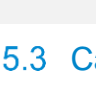
**Left-right navigator:** in idle state, use this key to move from one page to another. In conversation, use this key to move between tabs of current calls (call in progress, calls on hold, incoming call). In the text edition, use this key to navigate into the text box.
- 

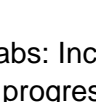
**Up-down navigator:** used to scroll through the content of a page.
- 

**Back/Exit key:** use this key to go back to the previous step. Use this key to go back to the homepage (long press). Use this key to delete one number or character at a time.
- 

Manage your call forwarding by pressing the key associated with the forward icon.

  -  Stationary white icon: no forwarding activated.
  -  Rotating arrow: forwarding activated.

### 1.5.3 Call management screen

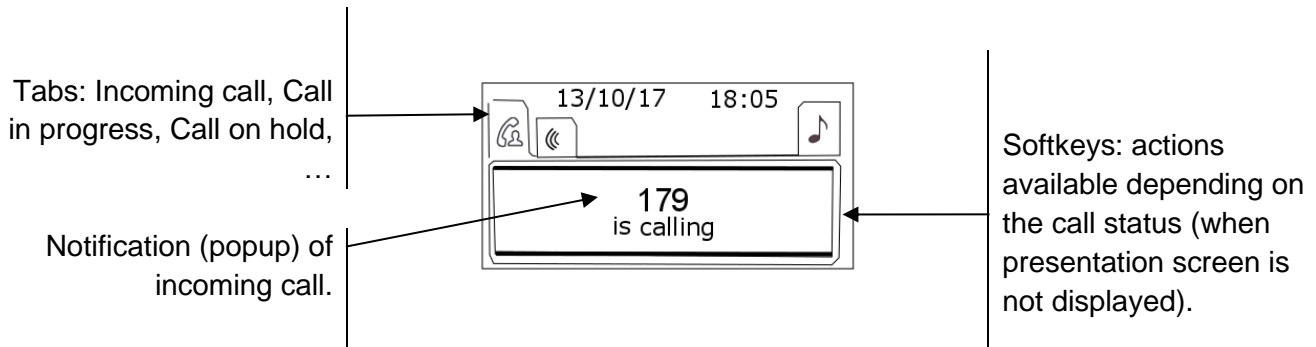

- 

Each tab corresponds to a call, the status of which is symbolized by its icon (in progress, call on hold, arrival of new call). When a call is in progress, use the left-right navigator to look at calls on hold or incoming calls.
- 

All features are accessible while the call is displayed on the screen. Use the Up and Down arrows to move up or down a page. These functions (transfer, conference, etc.) are directly related to the status of the call consulted. For example, the transfer function will not be available between a call in progress or on hold and an incoming call.
- 

Use to switch to the main screen during conversation to access some functions, for example, searching by name.
- 

Press the key in front of the label to select the corresponding feature.

Calls can also be managed from the Perso page.

While the call is in progress, press the Back/Exit key and display the Perso page. Calls in progress or waiting calls are displayed on the different line keys. It is then possible to converse with the contact of your choice by pressing the key associated to the contact.



## 1.5.4 Changing or updating the paper label

### Removing the paper label

- Lift the protective cover at the notch and slide it up to take it out of its housing.
- Remove the paper label in the same way.
- Update or replace the paper label.

### Inserting the phone label

- Insert the paper label from the top end, making sure it is placed correctly behind the notches.
- Put the protective cover back in the same way.

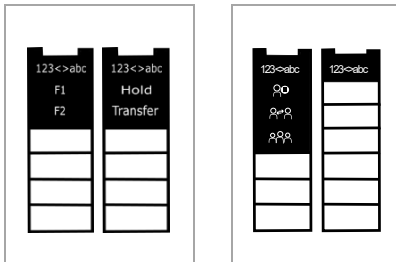

The paper label is printed on both sides for pre-programmed keys. Two types of paper are available. According to your system and the pre-programmed keys, insert the paper on the right side. Contact your administrator for more information.

The application 'LabelSet' is available to help you to print the paper labels. Please contact your business partner for more information.

Paper label and paper label cover can be ordered separately.

## 1.5.5 Function keys and programmable keys



The 8018 DeskPhone uses 3 preprogrammed keys to access some features. In this case, the icon of the feature is printed on the paper. Use the feature by pressing the corresponding key. When activated, the LED corresponding to the key remains lit up. Press the corresponding key to deactivate it.

- **123<>abc** Alpha-numerical keypad  
Use this key to switch between alphabetic keyboard and numeric keyboard.
- **F** Programmable keys (F1 and F2 keys). A service or a direct call can be associated to these keys.

## 1.6 8008 / 8008G DeskPhone

This phone is part of the IP phone range. In addition to a clear monochrome display with six dedicated function keys and an intuitive navigation key, the 8008 DeskPhone provides high audio fidelity for telephone calls either in hands-free mode or using the comfortable handset. It is compatible with remote working. Consequently, it is perfect for use in your Enterprise office or in Home working.

The phone is available in two versions: 8008 DeskPhone, 8008G DeskPhone. The 8008G DeskPhone is equipped with a monochrome backlit screen and a gigabit Ethernet connection.

### 1.6.1 Phone description



- 1 8008: monochrome screen.  
8008G: monochrome backlit screen.  
LED
- 2 Flashing blue: incoming call / appointment alarm.
- 3 6 dedicated functions keys.
- 4 Navigation, ok and cancel keys.
- 5 3 preprogrammed keys with LEDs: Alpha-numeric key, F1, F2.
- 6 Messaging key to access various mail services.
- 7 Mute and interphony key.
- 8 Audio feature keys.
- 9 Redial key.
- 10 Loudspeaker.
- 11 Wired handset (wide band audio quality).
- 12 Stable foot.

A corded headset can be connected via RJ9 connector (See: Description of the connectors). Use an adapter RJ9 to connect a headset (3GV28177AA).

## 1.6.2 Main screen and navigation keys

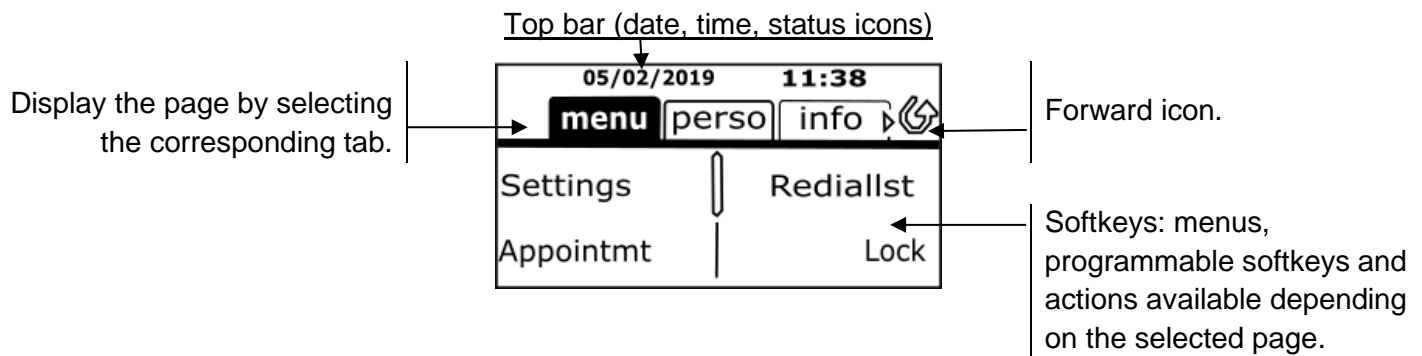

**OK key:** use this key to validate your choices and options while programming or configuring.

**Left-right navigator:** in idle state, use this key to move from one page to another. In conversation, use this key to move between tabs of current calls (call in progress, calls on hold, incoming call). In the text edition, use this key to navigate into the text box.

**Up-down navigator:** used to scroll through the content of a page.



**Back/Exit key:** use this key to go back to the previous step. Use this key to go back to the homepage (long press). Use this key to delete one number or character at a time.



Manage your call forwarding by pressing the key associated with the forward icon.

- Stationary white icon: no forwarding activated.
- Rotating arrow: forwarding activated.

## 1.6.3 Call management screen

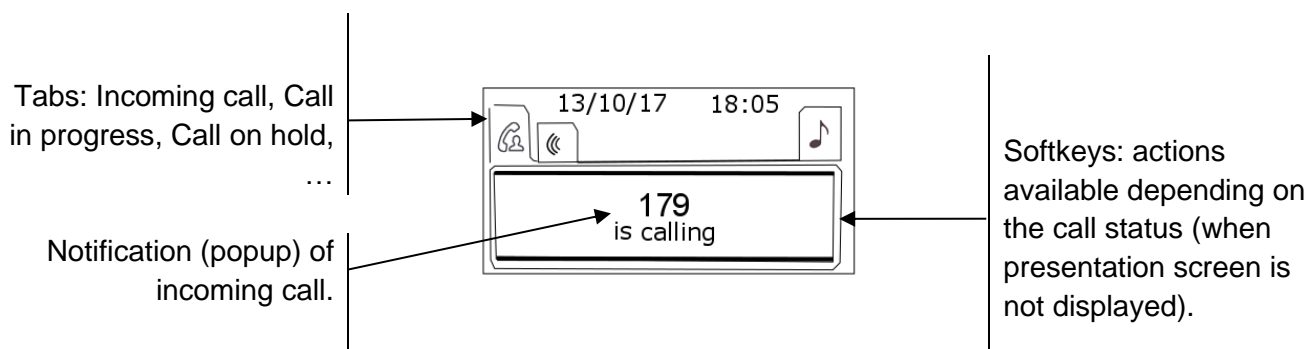

Each tab corresponds to a call, the status of which is symbolized by its icon (in progress, call on hold, arrival of new call). When a call is in progress, use the left-right navigator to look at calls on hold or incoming calls.



All features are accessible while the call is displayed on the screen. Use the Up and Down arrows to move up or down a page. These functions (transfer, conference, etc.) are directly related to the status of the call consulted. For example, the transfer function will not be available between a call in progress or on hold and an incoming call.



Use to switch to the main screen during conversation to access some functions, for example, searching by name.



Press the key in front of the label to select the corresponding feature.



Calls can also be managed from the Perso page.

While the call is in progress, press the Back/Exit key and display the Perso page. Calls in progress or waiting calls are displayed on the different line keys. It is then possible to converse with the contact of your choice by pressing the key associated to the contact.

### 1.6.4 Function keys and programmable keys



The 8008/8008G DeskPhone uses 3 preprogrammed keys to access some features. In this case, the icon of the feature is printed on the paper. Use the feature by pressing the corresponding key. When activated, the LED corresponding to the key remains lit up. Press the corresponding key to deactivate it.

-  Alpha-numerical keypad  
Use this key to switch between alphabetic keyboard and numeric keyboard.
-  Programmable keys (F1 and F2 keys). A service or a direct call can be associated to these keys.

### 1.7 Symphonic HD (Super Wideband audio)



Symphonic HD, or super Wideband audio, is high definition voice quality for telephony audio. The frequency range of audio signals uses a wider frequency spectrum to deliver high voice quality. Your desk phone is compatible with Super Wide Band audio. Enjoy Symphonic HD audio quality in hands-free mode, with the super wideband comfort handset, with a compatible headset or

by using your phone as an audiohub.

Your desk phone's comfort of use is greatly improved thanks to the Super Wideband audio.



Symphonic HD depends on the desk phone and the audio equipment.

	8078s BT	8078s	8068s BT	8068s	8058s	8028s	8018	8008 8008G
Hands-free	●	●	●	●	●			
Super Wide Band Comfort Handset	●	●	●	●	●			
Super Wide Band compatible wired headset	●	●	●	●	●			
Bluetooth® handset or headset <sup>1</sup>								

<sup>1</sup> Super Wide Band audio is not compatible with Bluetooth®.

 Symphonic HD audio depends also on the equipment of your contact. During conversation, the HD logo is displayed to inform you that the conversation is Super Wide Band audio ready. In other words, if you are using compatible equipment, you are in Super Wide Band audio.

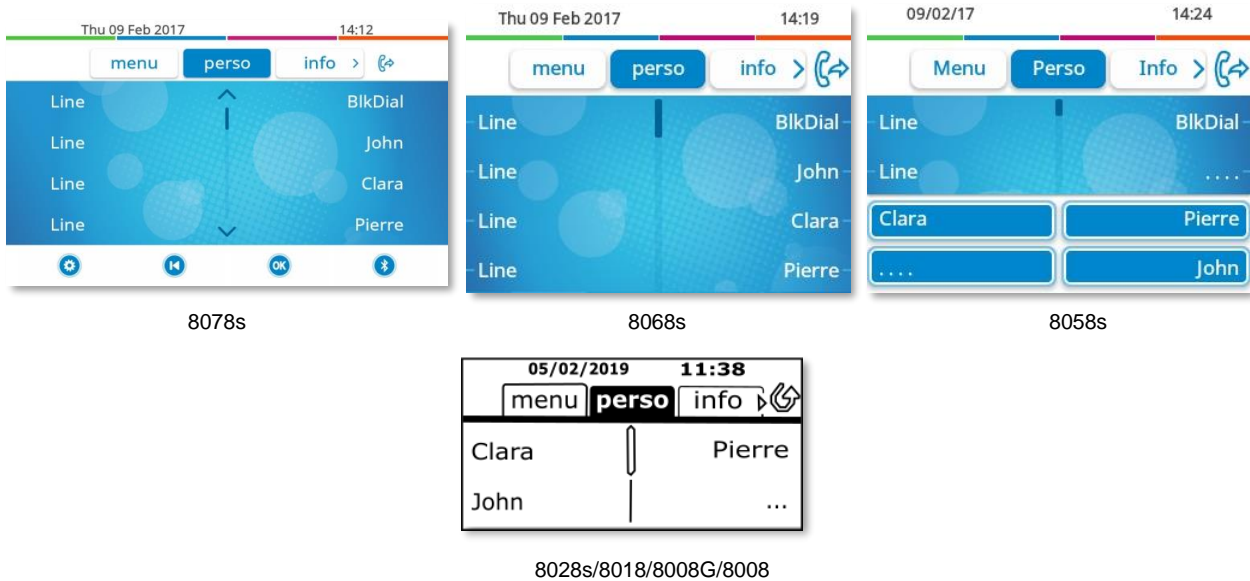

The compatible desk phone offers a choice of key ringtones including 16 new Super Wide Band ringtones.

## 1.8 Welcome screens



### 1.8.1 Homepage description

You can access all of your phone's features from these screens. The default display has three pages that you can access by pressing to the page tabs at the top of the screen. The selected page is highlighted. The default pages can be augmented with other applications (ACD for example) installed and/or configured on your system.



- Menu page *Menu*  
Contains all features and applications accessible by pressing the label of the desired feature or application. From this page, it is possible to adjust the ringer volume, program the time of an appointment, lock the terminal, define the default page displayed, configure voice mail, and access telephone functions such as calling back one of the last numbers or intercepting calls.
- Perso page *Perso*  
Contains call line keys (allowing supervision of calls) and programmable call keys.
- Info page *Info*  
Contains information on the telephone and the status of its functions: name, telephone number, number of messages (including call log events, text messages and voice messages), activation of transfer function, appointment reminder, etc.
-  /  Forward icon  
Press the icon (touchscreen) or the key next to this icon to program or change the transfer function.
- Press the label (touchscreen) or press the key in front of the label to select the corresponding feature.
- The 8058s Premium DeskPhone provides 4 programmable softkeys. Press the key in front of the softkey to activate it (call a contact, forward to a number, ...).

### 1.8.2 Choose the page displayed by default on the telephone

- *Settings* > *Phone* > *Homepage*
- Select the default page (Menu, Perso, Info, Last page seen ...).
- **OK**

## 1.9 User local menu

Only available on: 8078s BT, 8078s, 8068s BT, 8068s, 8058s, 8028s.

 Or  (long press): open the user local menu.

The User Local menu can also be accessed from the system MENU: Reach the 'Menu' page [› Settings](#) [› Phone](#) [› Local Menu](#)

: This icon is only available on the 8078s Premium DeskPhone.

The user local menu depends on the type of the set.

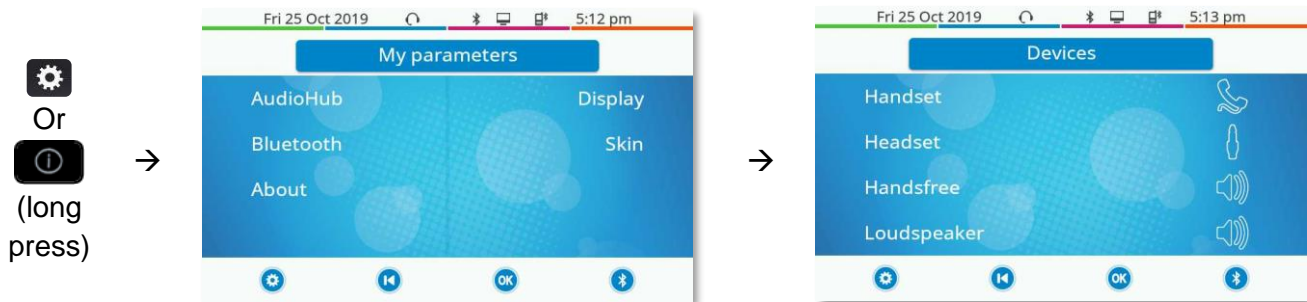

### AudioHub

Use this menu to adjust the audio convenience according to your environment, the type of device connected and your audio preferences:

- [Devices](#)  
Select the preferred audio device (connected or integrated).
- [Jack](#) [› EHS](#)  
Adjust the behavior of the phone depending on the connected device ([Jack ring.](#), [Rainbow](#), [ACOM jack only](#)).
- [Jack](#) [› Jack config.](#)  
Configure the type of the device connected to the audio jack ([Headset](#), [Handsfree](#), [Loudspeaker](#)).
- [USB](#) [› USB Link](#)  
Use this menu to configure your desk phone to use it as a USB audiohub. You have to check this option before using your desk phone as a USB audiohub.
- [Bluetooth](#) [› Shared phone](#)  
Use this menu when you are using your desk phone as a Bluetooth® Audiohub. Check this option if the desk phone is shared (in a meeting room for example).
- [Ambiences](#)  
This menu offers different audio ambience for your convenience ([Neutral](#), [Bass Boost](#), [Clarity](#), [Legacy](#)).
- [Hearing Aid](#)  
Check this option if you are using a hearing aid.

### Display

Use this menu to adjust the display of your set:

- [Auto-Brightness](#)  
When this option is checked, the phone automatically adjusts the brightness of the display depending on the lighting conditions to improve user experience and achieve power savings (ambient light sensor).
- [Brightness](#)  
Adjust the brightness of the display, the LEDs and the logo on back shell (optional).
- [Screensaver](#)  
Set the delay before the brightness is dimmed when the phone is not in use.
- [Advanced](#) [› Low brightness](#)  
When the phone is not in use, the brightness is dimmed. Adjust dimmed brightness.

- [Advanced](#) ▶ [Busy light](#)  
Activate/deactivate the light of the logo on back shell (optional). The logo on back shell can be illuminated. The color changes when you are busy.
- [Advanced](#) ▶ [LED Auto-Brightness](#)  
When this option is checked, the phone automatically adjusts the LED brightness and the busy light logo on the back shell (if present) depending on the lighting conditions to improve user experience and achieve power savings (ambient light sensor).

### Bluetooth

Use this menu to configure the Bluetooth® device (optional):

- [Devices](#)  
Display all paired Bluetooth® devices, remove a Bluetooth® accessory (headset, handset, etc.).
- [Parameters](#)  
Use your DeskPhone as a Bluetooth® audio accessory.
- [Search devices](#)  
Install a Bluetooth® Wireless accessory (headset, handset, etc.).
- [Noise cut](#)  
Improve the Bluetooth® audio quality when the Wi-Fi network interferes the Bluetooth® signal. We recommend not activating this option if it is not necessary because the autonomy of the Bluetooth® device will decrease.

 The 8078s Premium DeskPhone has a specific softkey (quick access) to manage Bluetooth® devices (add device, list of paired devices, remove device).

### Skin

Change the theme (skin) of your phone (optional).

### About

Use this menu to find information about the software and hardware releases of your desk phone.

Use this menu to obtain the link to the user manual of your desk phone or the link to the Rainbow™ home page.

- [Software](#)  
Display all information about your desk phone's software.
- [Hardware](#)  
Display all information about your desk phone's hardware (model, PCMS Number, serial number, mac address, Bluetooth ® address if available).
- [Documentation](#)  
Display a QR code to directly access documentation for your desk phone. Scan the QR code and open the URL in your favorite web browser.
- [Rainbow](#)  
Display a QR code to directly access the Rainbow™ homepage. Rainbow is the cloud-based collaboration application that connects you with your business community. Scan the QR code and open the URL in your favorite web browser.

## 1.10 Status icons/ Call icons

Icons giving information about some specific configurations of the phone or about call status are displayed in the top bar of the screen.

### Status icons

Depending on the size of the display, all status icons may not be displayed simultaneously. Which icons are displayed depends on their priority. The following icons are listed according to their priority, from the highest to the lowest.

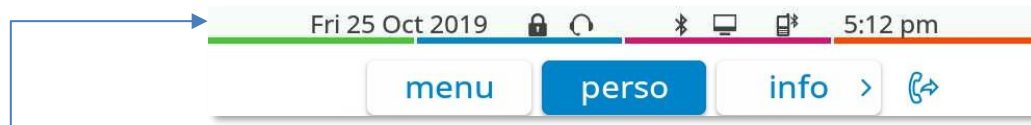

	Silent mode.
	Telephone locked.
	Headset connected.
	Handsfree connected
	Appointment programmed.
	Bluetooth ® accessory paired.
	Light color: a Bluetooth® mobile phone has been paired but it is not connected. Dark color: Bluetooth® mobile phone connected (the desk phone is used as Bluetooth® audiohub).
	Active Bluetooth ® connection.
	Encrypted signal icon.
	Wi-Fi enabled.
	Light color: USB audiohub activated. Dark color: audiohub is activated and a computer is connected to the desk phone.
	Symphonic HD audio is used during conversation.

### Call icons

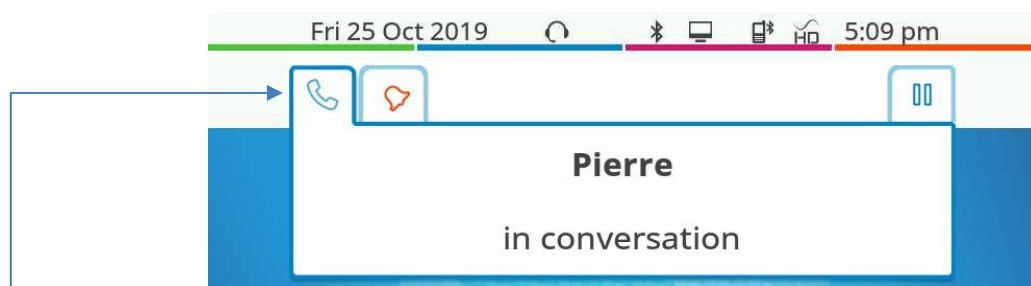































	Incoming call icon.
	Call in progress icon.
	Call holding icon.
	Your contact ended the conversation.
	Encrypted call in progress.



## 1.11 Permanent features keys

They are located just above the loudspeaker.

8078s 8068s 8058s 8028s	8018	8008 8008G	Description
			<ul style="list-style-type: none"> <li>Take the call key.</li> </ul>
			<ul style="list-style-type: none"> <li>Hang up key.</li> </ul>
			<ul style="list-style-type: none"> <li>Mute and interphony key. During a call, press this key to stop your contact from hearing you. When idle, press this key to switch the phone to interphony mode. When you receive a call, the phone hooks off automatically and you go straight into hands-free mode. When activated, this key is lit blue. Interphony can be disabled by the administrator.</li> </ul>
			<ul style="list-style-type: none"> <li>Turn down the volume (ringing or call state).</li> <li>Decrease the brightness (idle state).</li> <li>Decrease the contrast (idle state).</li> </ul>
			<ul style="list-style-type: none"> <li>Turn up the volume (ringing or call state).</li> <li>Increase the brightness (idle state).</li> <li>Increase the contrast (idle state).</li> </ul>
			<ul style="list-style-type: none"> <li>Pressing this key answers an incoming call in hands-free mode (when activated, the key is lit blue). When a call is in progress, pressing this key switches from hands-free mode to headset or handset mode. A long press activates the loudspeaker when a call is in progress via the handset or headset.</li> <li>When your desk phone is used as a Bluetooth® audiohub (only with a compatible Bluetooth® desk phone paired with your mobile phone), press and hold this key in idle state to open the call log or contact directory of your mobile phone on the desk phone, or to make a call on your mobile phone using your desk phone. This key (long press) is also used to facilitate the connection with your mobile phone (display the name and Mac address of the desk phone for pairing, direct connection if the mobile phone is already paired)</li> </ul>
			<ul style="list-style-type: none"> <li>Programmable keys (F1 and F2 keys). Lit when the function associated with the key is activated. A service or a direct call can be associated to these keys.</li> </ul>
			<ul style="list-style-type: none"> <li>Redial key: to access the 'Redial' feature. <ul style="list-style-type: none"> <li>Last number redial (short press).</li> <li>Call back one of the last 8 numbers dialed (long 'etat' press).</li> </ul> </li> </ul>
			<ul style="list-style-type: none"> <li>Quick access to user local menu (long 'etat' press).</li> <li>Used to obtain information on functions of the 'menu' page and to program key of the 'perso' page (short press).</li> </ul>
			<ul style="list-style-type: none"> <li>Switch between the alphabetic and numeric keyboards.</li> <li>Information about the user (long 'etat' press).</li> </ul>
			<p>Messaging key to access the messaging portal (call log, voice messages and text messages).</p> <p>This key flashes blue when there is a new event such as a new voice message, a new instant message or a new event in the call log. The key remains lit until all events are acknowledged or deleted.</p>

## 1.12 Keyboard

### 1.12.1 Magnetic alphabetic keyboard (8078s, 8068s, 8058s, 8028s Premium DeskPhone)

Your set is provided with a magnetic alphabetic keyboard. The keyboard depends on your country and languages. The magnetic keyboard is automatically fixed on the base of the set. It is connected to the corresponding connector behind the phone. Country variants: AZERTY, QWERTZ, QWERTY (international), QWERTY (nordic).



Use the keyboard to enter names while configuring the phone. Access directly the dial by name feature by entering the name of your contact on the keyboard.

Below is a list of the function keys that allow you to access all the symbols.

	Cursor moving keys (left, right, up and down). Allows you to navigate edit boxes. Press the Alt key to access the left and up directions.
	Caps lock: to write text in capital letters.
	Alt key: to access specific and punctuation characters.
	Enter key: to validate edited text.
	Backspace key: to delete one character in an edit box.

### 1.12.2 Alpha-numeric keyboard (8008/8008G/8018 DeskPhone)

Your phone is equipped with alphanumeric keyboard. You can switch between numeric keyboard to dial number, and alphabetic keyboard to enter text by pressing the corresponding preprogrammed key (usually the first preprogrammed key).

- **123<>abc** Switch the keyboard to the alphabetic mode by selecting the associated preprogrammed key. When activated, the LED corresponding to the key remains lit up.
- Enter alphabetic characters.  
The number pad keys have letters that you can display by successive presses. The number is the last character in the series. Some special characters can be displayed by successively pressing the key:

	%	\$	/	~	&	(	)	[	]	=	*
# key"/>	@	#									
	Space		-	_	1						
	+	.	,	;	:	\	?	!	<	>	0

- Use navigation keys to move the cursor into the text.
- Press and hold the '\*' key to switch from lowercase to uppercase mode, and vice versa.
- Use this key to delete the last entered character. The alphabetic mode remains activated.
- **123<>abc** Select the lit preprogrammed key to return to the numeric mode.

### 1.13 Connectors

### 1.14 Description of the connectors

Various connections to allow phone extensions. The type of connectors you have depends on your phone.

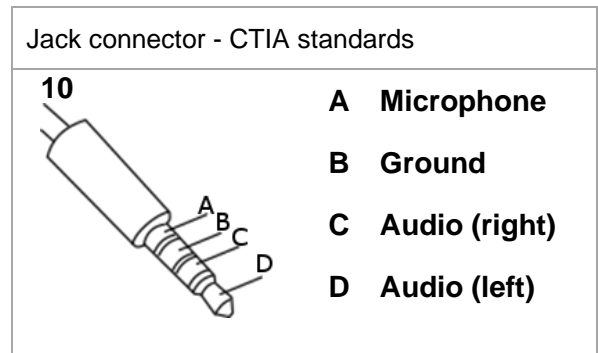
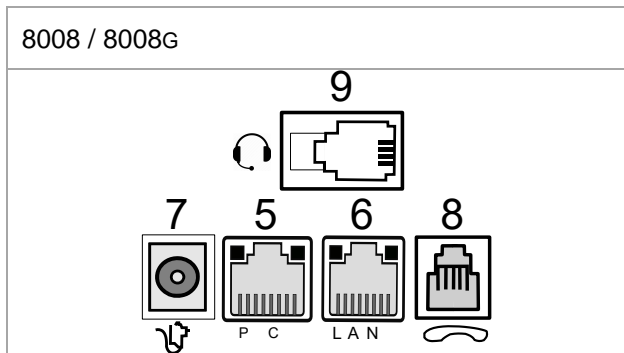
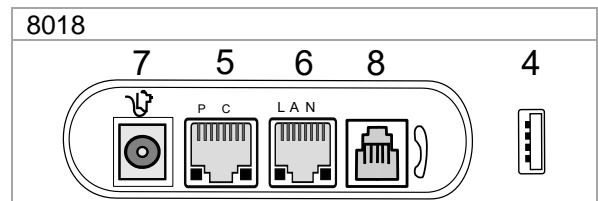
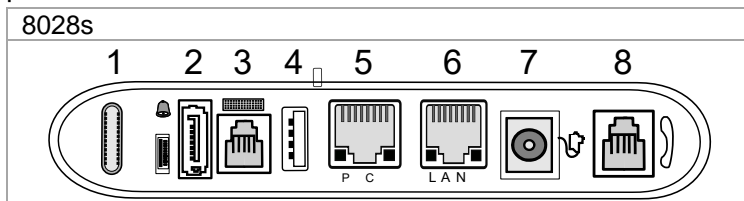

		8078s	8068s	8058s	8028s	8018	8008G	8008
1	Universal Serial Bus (USB-C) connector	●	●	●				
2	Add-on module/external ringing connector (SATA type).	●	●	●	●			
3	Magnetic alphanumeric keyboard connector (RJ 9).	●	●	●	●			
4	Universal Serial Bus (USB-a) connector. For the 8018 DeskPhone, the USB connector is on the side of the desk phone. The use of this connector depends on your desk phone: audio equipment, a low-energy smartphone charger, USB stick, Bluetooth® USB dongle provided with a Bluetooth® headset, beacon dongle or an external ringing module.	●	●	●	●	●		
5	10/100/1000 Mbps Ethernet connectors to a PC (RJ45).	●	●	●	●	●	●	
	10/100 Fast Ethernet connector (PC).							●
6	10/100/1000 Mbps Ethernet connectors to the enterprise network (LAN - RJ45).	●	●	●	●	●	●	
	10/100 Fast Ethernet connector (LAN).							●
7	DC power jack for an external power adaptor.	●	●	●	●	●	●	●
8	Wired handset connector (RJ9).	●	●	●	●	●	●	●
9	RJ9 connector for a corded headset.						●	●
10	3.5 mm, 4 pole jack (TRRS standards: CTIA).	●	●	●	●			

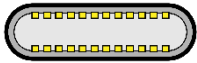
USB connectors (Universal Serial Bus)			
USB-A	USB type A		The USB Type A has a flat rectangle interface. It is not reversible and is able to transmit data or power.
USB-C	USB type C		The USB Type C is reversible and full duplex. It is able to transmit data, video or power.

### 1.14.1 Plug in the phone

The phone can be powered either via a power adapter (sold separately) or via Power over Ethernet (PoE).

### 1.14.2 USB boost

The USB boost feature allows a desk phone to get more power available from Power over Ethernet (PoE) than requested through a default startup, for several needs such as more USB current for accessories (smartphone charging). In this case, your administrator has to enable the USB Boost to deliver more power. After restart, the phone changes its USB current limiter management, to increase the available power from 500 mA to 900 mA and can change of PoE class.

Contact your administrator if necessary.

## 1.15 Add-on module

Depending on your DeskPhone, phone capabilities can be extended with add-ons:

	8078s BT	8078s	8068s BT	8068s	8058s	8028s	8018	8008 8008G
Premium Add-on 10 keys modules			●	●	●	●		
Premium Smart display 14 keys module	●	●	●	●	●	●		
Premium add-on 40-key modules	●	●	●	●	●	●		



### 1.15.1 Install the add-on to the desk phone

- **Premium Add-on 10 keys**

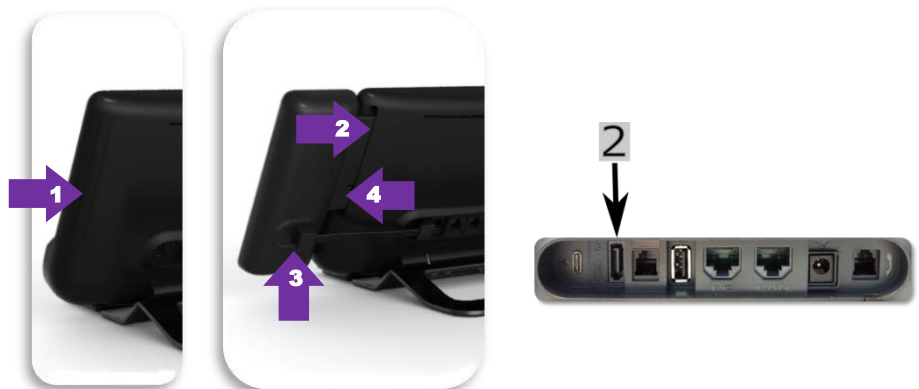

- Remove the protection of the dedicated compartment behind the set.
- Insert the add-on correctly in the compartment.

- Plug the provided cord into the dedicated sockets behind your set and the add-on (2: ).
- Fix the add-on with the provided screw.
- Restart the desk phone (unplug and plug in the power jack if you are using an external power adapter or the Ethernet connector – LAN).



- **Premium Add-on 40 keys / Premium Smart Display 14 keys:**

- Plug the provided cord into the dedicated socket behind your phone and behind the add-on (.
- If desired, fix the foots (set and add-on) with the provided clip.
- Restart the desk phone (unplug and plug in the power jack if you are using an external power adapter or the Ethernet connector – LAN).

Manage and use the add-on keys as a direct call key. See chapter: Programming your telephone.

### 1.15.2 Install more than one add-on module

It is possible to connect up to three add-on modules (Premium Smart Display 14 keys, Premium Add-on 40 keys). To attach another add-on, affix and connect the new add-on to the one that is already connected:

- The first add-on is connected to the desk phone.
- Plug the provided cord of the new add-on into the dedicated socket behind the connected add-on (  ).
- Plug the other end of the cord into the dedicated socket behind the new add-on (  ).
- Restart the desk phone (unplug and plug in the power jack if you are using an external power adapter or the Ethernet connector – LAN).

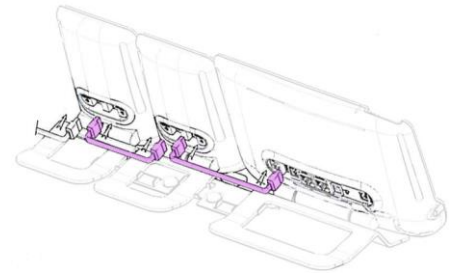

### 1.15.3 Attach the add-on with the clip

You can also order this clip separately for each of the two add-on modules. You can attach the base (set and add-on module) with the add-on clip provided with Premium Add-on module 40 keys and Premium Smart Add-on module 14 keys.

#### Premium Smart Add-on

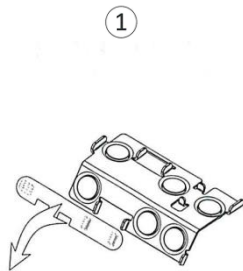

Remove the protection on the add-on clip

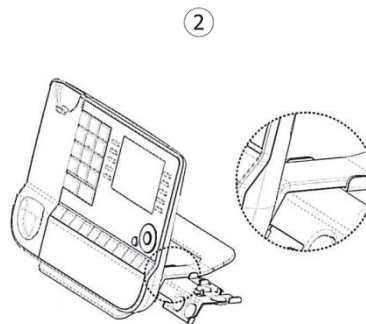

Place the clip in the correct position under the base of the phone, as shown in the image

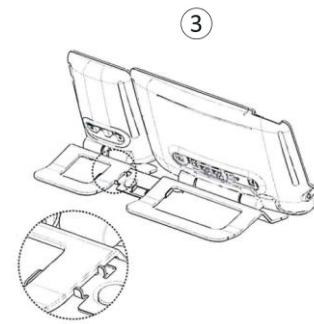

Place the add-on onto the clip, as shown in the image

#### Premium Add-on 40

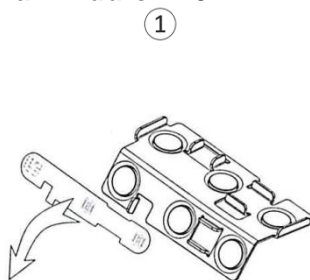

Remove the protection on the add-on clip

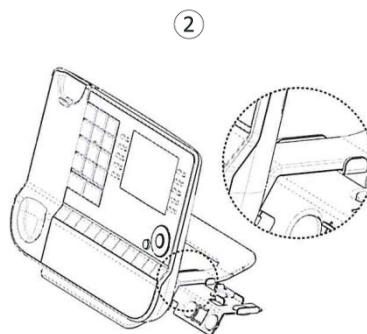

Place the clip in the correct position under the base of the phone, as shown in the image

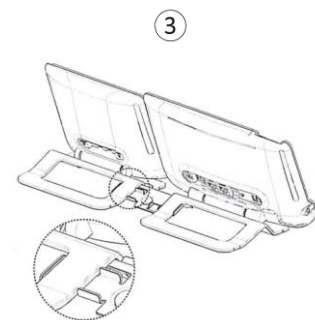

Place the add-on onto the clip, as shown in the image

Use the same procedure to attach an add-on to another add-on.

You can attach one or more add-ons to your phone. To attach another add-on, affix and connect the new add-on to the one that is already connected.

## 1.15.4 Changing or updating the paper label

- **Premium Add-on 10 keys (With paper labels)**

- Remove the protective cover (1): insert a thin object (or your fingernail) in the slot (a) to lift the protective cover. Carefully remove the cover at the first notch (b). The cover is held in place by small notches, take care not to break the plastic cover near the notches. Remove the cover from the other notches (c, d) by moving the cover gently from right to left (←→).
- Remove the paper label with a thin object.
- Replace the paper label and protective cover (2): the cover or the paper can only be placed in the right way. It has to cover all the paper area. If not, return it. Position the paper label, right side first, by inserting it under the plastic notches (a). Then, insert the other notches (b) by gently pressing the paper near each notch. Put the protective cover back in the same way.

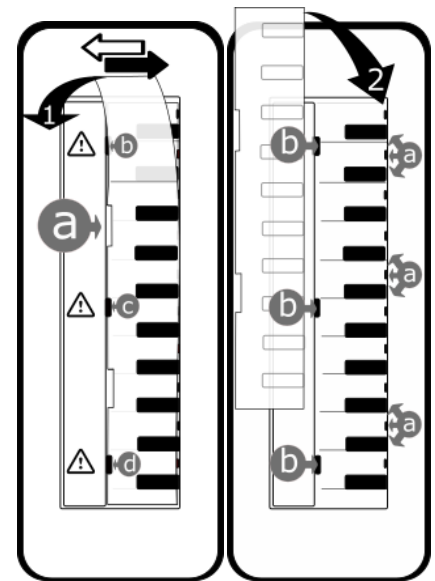

- **Premium Add-on 40 keys (With paper labels)**

- Remove the protective cover (1): insert a thin object (or your fingernail) in the correct position (a) to lift the protective cover. Carefully remove the protective cover. The cover is held in place by small notches, take care not to break the plastic cover near the notches.
- Remove the paper label in the same way
- Replace the paper label and protective cover (2): the cover or the paper can only be placed in the right way. It has to cover all the paper area. If not, return it. Position the paper label, right side first, by inserting it under the plastic notches (c). Then, insert the other notches (b) by gently pressing the paper near each notch. Put the protective cover back in the same way.
- Follow the same method for each paper area.

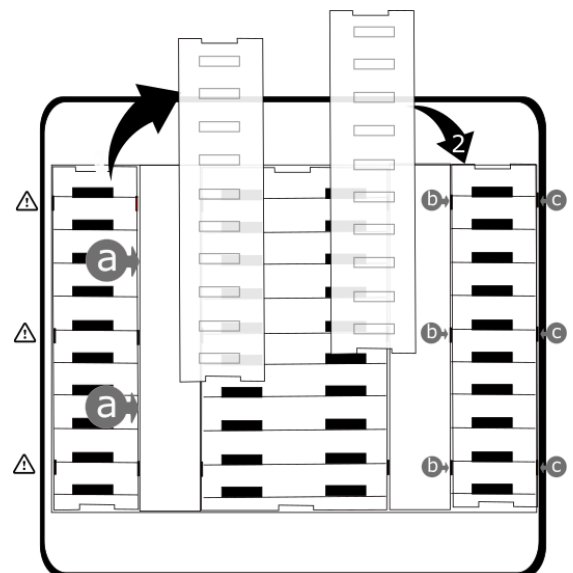

The application 'LabelSet' is available to help you to print the paper labels. Please contact your business partner for more information.

## 1.16 Next generation of Bluetooth® handsets (ALE Wideband Bluetooth® Handset)

The Bluetooth® Wireless handset is only available with compatible Bluetooth® desk phones.

	8078s BT	8078s	8068s BT	8068s	8058s	8028s	8018	8008 8008G
ALE Wideband Bluetooth® Handset	●		●					

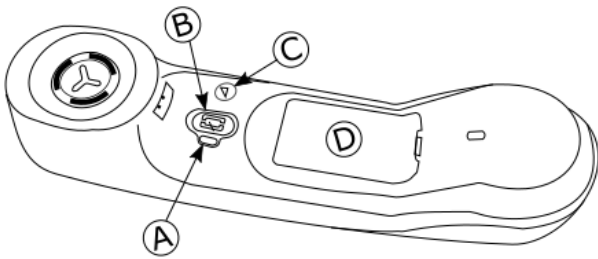

A	<p><b>LED</b> (front and back of the device)</p> <ul style="list-style-type: none"> <li>LED off: the handset is charging on its base or is switched off. When you put the handset on its base, the LED turns blue briefly and turns off again when the battery starts to charge.</li> <li>Blue flashing: normal operation.</li> <li>Red slow flashing: battery charge low. If voice prompts are enabled, you hear: "Battery low".</li> <li>Red fast flashing: handset outside coverage zone. If voice prompts are enabled, you hear: "Out of Range".</li> <li>Red steady: handset not paired.</li> </ul>
B	<p><b>Line key</b></p> <ul style="list-style-type: none"> <li>Switch the device on/off: press and hold to switch the device on/off. If voice prompts are enabled, you hear: "Power On / Power Off".</li> <li>Off-hook/On-hook: press this key to take or terminate a call.</li> <li>Voice prompts (in idle state): double press to enable the voice prompt.</li> </ul>
C	<p><b>Volume/Mute key</b></p> <ul style="list-style-type: none"> <li>Volume (during conversation): press in quick succession to change the handset volume level.</li> <li>Mute (during conversation): press and hold to ensure your correspondent no longer hears you.</li> <li>Voice prompts (in idle state): double press to disable the voice prompt.</li> </ul>
D	<ul style="list-style-type: none"> <li>Location of the battery.</li> </ul>

If the Bluetooth® handset is on its base, you do not need to press the Off-hook/On-hook key to take or terminate the call. Just off-hook/on-hook the Bluetooth® handset

The battery recharges when the Bluetooth® handset is on its base. When you put the handset on its base, the LED turns on briefly and turns off again when the battery starts to charge. The battery autonomy is more than 10 hours in conversation, and 50 hours in idle state. Charge the battery for about 6 hours before initial use.



If you are not going to use the handset for a long time, we recommend that you switch off the device by using the switch at the top of the battery compartment.

### 1.16.1 Voice prompts

The voice prompts help you to manage functions of the handset. Voice prompts are available in 5 languages. The default language is English. To hear the prompt, the handset has to be near your ear. To select the next language, with the handset turned on, double press the 2 keys of the handset (B,C) at the same time. You hear the new selected language. Repeat until the desired language is reached. To disable the voice prompts, with the handset turned on, double press the Volume/mute key (C). You are notified with a long beep. To enable the voice prompts, with the handset turned on, double press the Line key (B). You are notified with 2 short beeps.

### 1.16.2 Installing or replacing the Bluetooth® handset battery

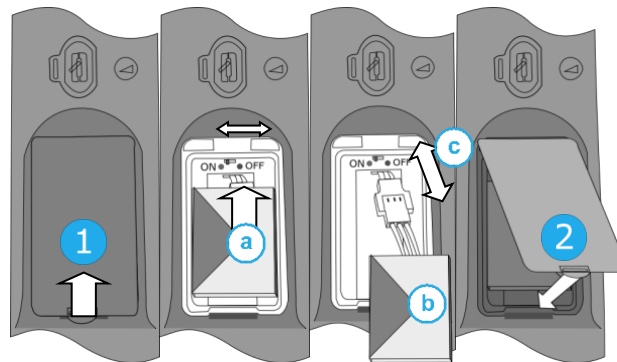

During the first use, to activate the battery, you have to set the switch to ON:

- 1- Lift up the battery cover.
  - a. Set the switch at the top of the compartment to ON using a pencil point.
- 2- Put the cover back on.



To replace the battery, with the handset turned off:

- 1- Lift up the battery cover.
  - a. Set the switch at the top of the compartment to OFF using a pencil point.
  - b. Lift up the battery using the tab to help you.
  - c. Disconnect the old battery and replace it with the new one by joining the 2 connectors. Arrange the battery, the cable and the connectors in the compartment.
- a. Set the switch at the top of the compartment to ON using a pencil point.
- 2- Put the cover back on.

A spare battery can be ordered from your business partner.



### 1.16.3 Pairing and connecting the Bluetooth® wireless handset

Before the Bluetooth® handset can be used, it must be correctly paired to the terminal. Pairing will create a wireless link between the Bluetooth® wireless handset and the desk phone.

- 1- Set your desk phone to 'discover' the Bluetooth® wireless handset
  - Use one of the following:
    - 
    -  (long press) › *Bluetooth*
  - *Search devices*
- 2- Put the handset in detectable mode
  - With the handset turned on, press and hold the 2 Bluetooth® handset keys (B, C) at the same time. If voice prompts are enabled, you hear: "Pairing mode, waiting for connection" ». The LED flashes red and blue alternately.
- 3- Connect the handset with the desk phone
  - Searching for Bluetooth® equipment. Wait for the detected equipment type and address to be displayed.
  - Select the Bluetooth® wireless handset displayed in your desk phone: "ALE BT WB Handset".
  - Add the device by selecting the relevant menu on your desk phone (Depending on the desk phone).
  - If voice prompts are enabled, you hear: "Device connected". The 3-note tone indicates that the handset has been installed correctly. The LED flashes blue or red depending on the battery charge level.

The handset is correctly connected if it appears in the list of connected devices on your desk phone. Press the Line key of the handset to test the connection, your desk phone will prompt you to enter a number.

If a Wi-Fi network interferes the Bluetooth® signal, you can activate the following option to improve the Bluetooth® audio quality:

- Use one of the following:
  - 
  -  (long press) › *Bluetooth*
- *Noise cut: check this option.*



Note that the autonomy of the Bluetooth® device will decrease if the option is enabled.

Please contact your installer if you encounter any problems. Before contacting your installer make sure you have information such as the serial number, the date code and the technical reference that you can find on the battery.

## 1.17 First generation Bluetooth® handset (ALE Bluetooth® Handset)

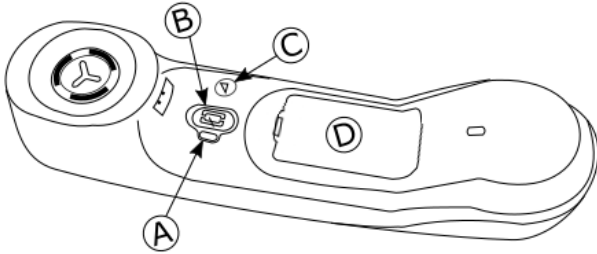
The Bluetooth® Wireless handset is only available with compatible Bluetooth® desk phones.



<p><b>A</b></p>	<p><b>LED</b> (front and back of the device)</p> <ul style="list-style-type: none"> <li>• Off: operating normally.</li> <li>• Green flashing: in communication.</li> <li>• Green steady: handset charging.</li> <li>• Orange flashing: battery charge low or handset outside coverage zone.</li> <li>• Orange steady: malfunction</li> </ul>
<p><b>B</b></p> 	<p><b>Line key</b></p> <ul style="list-style-type: none"> <li>• Switch the device on/off: press and hold to switch the device on/off.</li> <li>• Off-hook/On-hook: press this key to take or terminate a call.</li> </ul>
<p><b>C</b></p> 	<p><b>Volume/Mute key</b></p> <ul style="list-style-type: none"> <li>• Volume (During conversation): short successive presses to change the handset volume level (3 levels).</li> <li>• Mute (During conversation): long press to activate or deactivate mute mode.</li> </ul>
<p><b>D</b></p>	<ul style="list-style-type: none"> <li>• Location of the battery.</li> </ul>

If the Bluetooth® handset is on its base, you do not need to press the Off-hook/On-hook key to take or terminate the call. Just off-hook/on-hook the Bluetooth® handset.

### 1.17.1 Installing or replacing the Bluetooth® handset battery

At the first use, you have to connect the battery to the handset. The battery is placed in its compartment but it is not connected. To install a new battery, follow instruction:

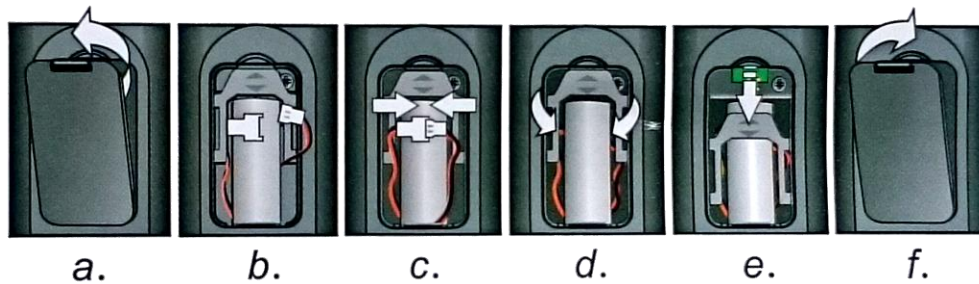

- a) Lift up the battery cover.
- b) Take the 2 connectors.
- c) Assemble the 2 connectors.
- d) Arrange the battery, the cable and the connectors in the battery compartment (place the connected side of the battery in the bottom of the compartment)
- e) Slide out the battery holding part.
- f) Replace the cover.

The battery recharges when the Bluetooth® handset is on its base.



Switch on / off the Bluetooth® handset: long press on the off-hook/on-hook key.

Defective batteries must be returned to a collection point for chemical waste disposal.

### 1.17.2 Pairing and connecting the Bluetooth® wireless handset

This feature is only available with compatible Bluetooth® desk phone. Otherwise the corresponding menu is not displayed or is inactive.

#### 1- Set your desk phone to 'discover' the Bluetooth® wireless handset

- Use one of the following:
  - 
  -  (long press) › *Bluetooth*
- *Search devices*

#### 2- Put the handset in detectable mode



-  Keeping the handset turned off, press and hold the 2 Bluetooth® handset keys (B, C) at the same time. You will hear a 3 note signal and the LED will flash green and orange alternately.

#### 3- Connect the handset with the desk phone

- Searching for Bluetooth® equipment. Wait for the detected equipment type and address to be displayed.
- Select the relevant equipment: ALE BT Handset.
- *Add*
- Enter the PIN code of the device if necessary.
- *Confirm* ›› The 3-note tone indicates that the handset has been installed correctly. The LED flashes green or orange depending on the battery charge level.
-  Go back to the Homepage.

The handset is correctly connected if it appears in the list of connected devices on your desk phone. Press the Line key of the handset to test the connection, your desk phone will prompt you to enter a number.

If a Wi-Fi network interferes the Bluetooth® signal, you can activate the following option to improve the Bluetooth® audio quality:

- Use one of the following:
  - 
  -  (long press) › *Bluetooth*
- *Noise cut: check this option.*

Note that the autonomy of the Bluetooth® device will decrease if the option is enabled.

Please contact your installer if you encounter any problems. Before contacting your installer make sure you have information such as the serial number, the date code and the technical reference that you can find on the battery.

## 1.18 Comfort wired handset

Your phone is provided with one of the following handset models. Both models are distinguished by the earpiece: the openings are different.

### 1.18.1 Super Wide Band Comfort Handset

This handset is super wide band audio compatible (Symphonic HD). It offers the best audio quality if your desk phone is compatible with Symphonic HD audio. This handset supports the next generation of audio and delivers a rich, clear and detailed audio experience as if your contact is in the same room as you.

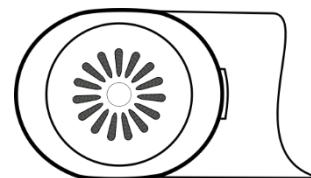

The Super Wide Band Comfort handset can be ordered separately. For more information, contact your installer or administrator.

### 1.18.2 Wide Band Comfort Handset

This handset is wide band audio compatible. It offers high audio quality.

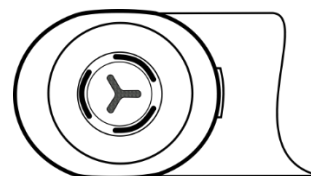

The super Wide Band Comfort handset is delivered with phone marked with the 'Symphonic HD' logo except for Bluetooth® models (delivered with a Bluetooth® handset).

	8078s BT	8078s	8068s BT	8068s	8058s	8028s	8018	8008 8008G
	●	●	●	●	●			

### 1.18.3 Install a comfort wired handset

- Remove the rubber.
- Plug-in the wired handset to the appropriate connector (refer to phone description).
- Make sure you position the cable correctly in the compartment intended for that purpose.
- Switch off the Bluetooth® Wireless Handset (press and hold the On/Off hook key until you hear distinct tones) (8078s BT, 8068s BT).

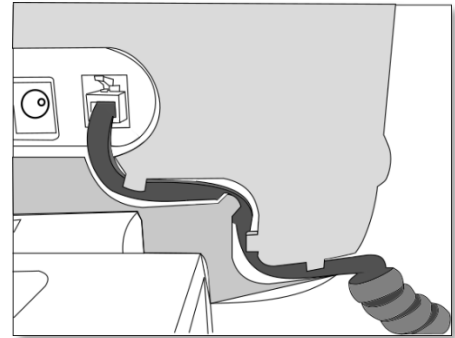

You can install a wired handset in place of the Bluetooth® Wireless Handset (8078s BT, 8068s BT).

### 1.19 Audio encryption

Your desk phone supports telephony encryption. On a secured telephone network (IPTouch Security, SSM box), voice and signaling are encrypted.



If the communication is encrypted, the following icon is displayed in the communication screen. The call in progress icon is replaced by this icon.



In idle state, the following icon is displayed in the status bar to indicate that the signal is encrypted (Depending on the icon priority, see chapter:Status icons).

Your phone supports many audio and signal encryption types. The native encryption mode is defined in the local administrator menu of the phone (*Native Encrypt*). For more information, contact your installer or administrator.

## 2 Using your telephone

### 2.1 Identify the terminal you are on

The number of your telephone is displayed on the 'Info' page.









### 2.2 Consulting the call log

At any time, you can consult all answered and unanswered incoming and outgoing calls.

- 
- *Call Log*



#### 2.2.1 Consulting all calls

All calls are displayed with an icon giving information on the type of call.

		Answered outgoing calls.
		Unanswered outgoing calls.
		Answered incoming calls.
		Unanswered incoming calls.





- Using the up and down navigation key to scroll through the log (If more than one page).
- Display the contact information by selecting it in the list. Information such as the name, phone number, date and time are displayed on the screen.
- You can choose to call the contact or clear the log:
  - *Recall*: call back the contact.
  - *Delete*: delete the entry.
  - *Delete all*: delete the entire log.

#### 2.2.2 Delete all call logs

- Use one of the following:
  - Press the key associated with the icon:  .
  - Display the contact information by selecting it in the list.  
*Delete all*
-  Or *Yes*: To confirm (*No*: To cancel).  
All call logs are deleted.

## 2.3 Making a call

Use one of the following:

- Dial the destination number. The hands-free mode is activated automatically.
- Unhook the handset › Dial the destination number.
- Press the Off-hook key of the headset › Dial the destination number.
-  Press the on-hook/off-hook key of the Bluetooth® device (Bluetooth® Wireless handset) › Dial the destination number.
-  Hands-free › Dial the destination number.
- Programmed line key.
- Dial by name (enter the first letters of the contact's name on the alphapad and press OK to start the search).
-  Redialing from the call log.
-  Redial last number.

To make an external call, dial the outside line access code before dialing your contact number.

For the phones 8018/8008G/8008 DeskPhone, the redial key is associated with the Off-hook key when the phone is in idle state: .

If the internal or outside number does not reply







- *LS announce* › Broadcast a message on the loudspeaker of the free terminal.
- *Call back* › Request callback to a busy terminal.
- *Text mail* › Send a written message.
- *Voice mail* › Store number to call again.

The hands-free mode can be deactivated by the administrator.

## 2.4 Receiving a call

Answer the call depends on audio devices connected to you phone: handset, headset, hands-free, external hands-free or loudspeaker.

Use one of the following:

- Lift the handset to take the call.
-  Press the On-Hook/Off-Hook key on the Bluetooth® handset to take the call (if handset is not on-hooked) - Bluetooth® Wireless handset.
- Press the On-Hook/Off-Hook key on the headset to take the call.
-  Or  Or  › Press the 'take the call', 'loudspeaker' or 'line key' key to take the call in hands-free mode.
- *Take call* Or  › Take the call with the headset if connected, or in hands-free mode.
-   Select the incoming call icon › Take the call with the headset if connected, or in hands-free mode.
- Press dedicated line key on external handsfree to take the call in hands-free mode on this device.

The hands-free mode can be deactivated by the administrator.



## 2.5 Ignore the call

A call is received:

- Press on the On-hook key on the permanent features keys panel.
- Your phone no longer rings but your caller still hears the ringing tone.

You can still answer the call after you have ignored it.

## 2.6 Switching between audio modes

During conversation, you can switch between different audio modes (handset, loudspeaker, hands-free or headset, if connected) by pressing the loudspeaker/hands-free key until the desired audio mode is displayed: . This feature depends on connected devices and the default device selected in the phone configuration. If you have connected the same type of accessory via different connection methods (for example, a headset to the jack connector, a headset to the USB connector and a Bluetooth ® headset), the default device is used for audio switching. The key is lit when the loudspeaker or hands-free mode is selected.

You are in conversation with the handset, you can switch between following audio modes by short pressing on the loudspeaker/hands-free key:



You are in conversation with the headset (headset or headset+loudspeaker), you can switch between following audio modes by short pressing on the loudspeaker/hands-free key:



You are in conversation with the headset and the handset is not hang-up, you can switch between following audio modes by short pressing on the loudspeaker/hands-free key:





To switch the audio to the headset, you have to press the Off-hook key of the headset.

You are in conversation, you can switch to the loudspeaker by long pressing on the loudspeaker/hands-free key (Group listening feature):













For each audio mode, during the conversation, you can adjust the volume by pressing the volume keys. The number of levels depends on the audio mode (8 for handset and headset 10 for hands-free and loudspeaker). The selected volume, for each audio mode, will be saved for future conversations.

- During a conversation.
-   Adjust volume by pressing the volume keys.

The hands-free mode can be deactivated by the administrator.

## 2.7 Activating the loudspeaker during a conversation (handset lifted) - Group listening feature

Activate or deactivate the loudspeaker when you are in conversation using the handset or the headset.



-  Activate loudspeaker (long press)   The key lights up ()
-   Adjust volume by pressing the volume keys (Number of levels: 10).
-  Deactivate loudspeaker (long press)   The key is no longer lit ()

Press and release the loudspeaker key to switch to hands-free mode (light steady).

## 2.8 Making calls by name (company directory)

This feature depends on the system configuration. If necessary, contact your administrator.

**123<>abc:** If your set is not provided with a magnetic keyboard, use the alpha-numeric keyboard to enter letters. You have to switch the keyboard to the alphabetic mode by selecting the associated programmed key. When activated, the LED corresponding to the key remains lit up.

- Enter the name of your contact: 'last name' or 'initials' or 'last name first name'.
- Select the type of search you want (last name, last name and first name or initials)  Display of all the contacts matching the search criteria.
- Use one of the following:
  - Use the navigation keys to display the previous and next names.
  - Select the name of the person you wish to call.
  -  Modify the search.

 If information about your contact is truncated, you can use the Guide key to display the complete information (8068s, 8058s, 8028s Premium DeskPhone).

## 2.9 Make calls via your programmed call keys (Perso page/F1 and F2 keys/Add-on module)

If you have programmed a direct call key, select it to make the call.

## 2.10 Redialing

### 2.10.1 Redialing the last number dialed (redial)

-  (short press) >> Last number redial.

### 2.10.2 Call back one of the last 8 numbers dialed

-  (long press).
- Select the number to redial from the last 8 dialed number.

For the phones 8018/8008G/8008 DeskPhone, the redial key is associated with the Off-hook key when the phone is in idle state: .

You can also access this feature through the menu:



- Reach the 'Menu' page.
- *Redial list* OR *Events* > *Redial list*
- Select the number to redial from the last 8 dialed number.



: Press the trash icon (or associated key) to delete the list of last dialed numbers.

## 2.11 Callback requests

The messaging key flashes when you have a callback request.

-  The messaging key flashes when you have a callback request.
- *Callback / xx Callbacks*
-  Select a callback request in the list if there is more than one. If there is only one callback request, it is displayed directly. Use navigation keys to browse the list.
- *Recall*

If there is only one callback request, it is displayed directly.





: Press the trash icon (or associated key) to delete the list of callback requests.

## 2.12 Call back an unanswered call



### 2.12.1 Call back the last caller

- Reach the 'Menu' page.
- *Events*
- *Last caller* >> Call back the last caller.

### 2.12.2 List of last callers

- Use one of the following:
  -  *Non replied call / xx Non replied calls*
  - Reach the 'Menu' page.  
*Events*
- Select the type of call:
  - *No non replied internal call / xx Non replied internal calls*
  - *No non replied external call / xx Non replied external calls*
-  Select a name or a number in the list if there are more than one. If there is only one name or number, it is displayed directly. Use navigation keys to browse the list.
- *Recall*
- To delete the selected item: *Delete*

### 2.12.3 Delete the list of unanswered calls

- Use one of the following:
  -  *Non replied call / xx Non replied calls*
  - Reach the 'Menu' page.  
*Events*
- Select the type of call:
  - *No non replied internal call / xx Non replied internal calls*
  - *No non replied external call / xx Non replied external calls*
- Use one of the following:
  - Select an entry  
*Delete all*
  -  Press the trash icon (or associated key).

## 2.13 Requesting automatic callback if internal number is busy

- Internal number busy.
- *Call back* >> Callback request acknowledged.
- 

## 2.14 Receiving interphony calls

You can answer a call without lifting the handset. When you receive a call, you are automatically connected in hands-free mode. The identity of the caller is displayed on the screen.

### To activate

-  (in idle state) >> Corresponding LED lights up.

When your caller hangs up, interphony mode remains active.

### To deactivate

-  (in idle state) >> The corresponding LED goes out.

Interphony can be disabled by the administrator.

## 2.15 Sending DTMF signals

During a conversation you sometimes have to send DTMF signals, such as with a voice server, an automated attendant or a remotely consulted answering machine.

Depending on the system configuration, the DTMF can be activated by default.

If DTMF is not activated by default on your system:

- During a conversation.
- Use one of the following:
  - *Send DTMF*
  - Press the star key.
- Enter DTMF code.

The function is automatically cancelled when you hang up.

If DTMF is activated by default on your system:



- During a conversation.
- Enter DTMF code.

If DTMF is activated by default on your system, you have to deactivate DTMF before entering the code of a feature: *Deactivate DTMF (Deact DTMF)*.

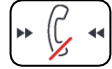

## 2.16 Mute, so that your contact cannot hear you

You can hear your contact but he/she cannot hear you:

### 2.16.1 From the set

- During a conversation.
-  Disable microphone >> The mute key blinks .
-  Resume the conversation >> The mute key no longer blinks .



### 2.16.2 From the Bluetooth® handset (Bluetooth® wireless handset)

- During a conversation.
-  Press the handset volume/mute key (long press) >> The mute key blinks.
-  Press the handset volume/mute key (long press) >> Resume the conversation >> The mute key no longer blinks

### 2.16.3 From the headset



- Use the mute key of the headset, if there is one, to disable headset microphone or to resume the conversation

## 2.17 Forwarding calls to your voice message service

- Select the forward icon (the icon depends on your phone:  / .
- *Imm fwd to VM (Imm fwd VM)* >> Forward is acknowledged.
- 

## 2.18 Consulting your voice mailbox

You are notified of a new event when the message key is flashing.

- 
- *New voice message / x New voice messages*
- Enter your personal code >> Display name of sender, with date, time and ranking of message.
- *Consult* >> Listen to message.
- When you have listened to the message, do one of the following.
  - *Replay* >> Replay message.
  - *Erase* >> Erase message.
  - *Call sender* >> Call back sender of message.
  - *Forward msg* >> Forward the message to another contact.
  - *Save* >> Archive the message.
  -  / *Exit* >> Terminate consultation.

## 2.19 Sending a text message to an internal contact

This feature depends on the system configuration. If necessary, contact your administrator.

**123<>abc:** If your set is not provided with a magnetic keyboard, use the alpha-numeric keyboard to enter letters. Use the alpha-numeric keyboard key to switch between the numeric and alphabetic keyboard. When in alphabetic mode, the LED corresponding to the key remains lit up.

- 
- *Text mail /New text message /New text messages*
- *Send*
- Use one of the following:
  - Enter the number of the terminal to receive the message.
  - Enter the first letters of the name.
- Choose the type of message.

### Sending predefined message

- *Predefined msg*
- Select a predefined message.
- *Apply*

### Sending a message to complete

- *To complete*
- Select a predefined message to complete.
- Complete your message.
- *Apply*

**Sending a new message**



- *To create (Msg to create)*
- Write your message.
- *Apply*

**Sending the previous message**

- *Previous msg*
- *Apply*

## 2.20 Consulting text messages

You are notified of a new event when the message key is flashing.

-  **>>** Number of messages received.
- *New text message/ New text messages*
- *Read message (Read msg) >>* Display name of sender, with date, time and ranking of message.
- Use one of the following:
  - *Scroll message (Scroll msg) >>* Scroll through the messages.
  - *Next message (Next msg) >>* Next message.
  - *Delete >>* Delete messages.
  - *Recall >>* Call back sender of message.
  - *Text answer (Answer txt) >>* Answer with a text message.
  -  **>>** Terminate consultation.

## 2.21 Lock / unlock your telephone

 This icon indicates that the phone is locked.

**Lock your phone**

- Reach the 'Menu' page.
- *Lock*
- Your phone is locked.
- 



**Unlock your phone**

- Reach the 'Menu' page.
- *Lock*
- Enter your password **>>** Your phone is unlocked.
- 

## 2.22 Making a second call during a conversation

- During a conversation.
- *New call >>* The first call is on hold.
- Number of second contact.

### 2.22.1 Other methods for calling a second contact

- Dial directly the number for your call.
- Name of second contact.
-  /  Select the 'Redial' function.
- Programmed line key.



### 2.22.2 Release the second call and recover the call on hold

- You are in conversation with the second contact and the first one is on hold.
- Use one of the following:
  - *Enquiry off*
  -  Hang up, your phone is ringing, then answer the call.
- You are on the line with your first contact.





If you make an error, hang up: your telephone will ring and you will recover your first call.

### 2.23 Answering a second call during a conversation

This feature depends on your system.

- During a conversation, another person is trying to call you >> Name or no. of the caller displayed for 3 seconds.
- Use one of the following methods to answer the displayed call (Multiline set).
  -   Select the incoming call icon.
  - *Take call*
- The first call is on hold.



To return to your first contact and end the conversation in progress.

-  >> The second call is ended.
- To return to the first contact, use one of the following.
  -   Select the incoming call icon.
  - 
  - Unhook the handset.

### 2.24 Switching between calls (Broker call)

During a conversation, a second call is on hold.

Use one of the following:

-   Select the call on hold icon from the conversation screen.
- Select the tab which is displaying the call on hold > *Retrieve*
- Press the Back/Exit key to display the Perso page > Select the call on hold.

>> You are in conversation with the second contact and the first one is on hold.

### 2.25 Transferring a call

- Calling a second person during a conversation >> The first call is on hold.
- You can transfer the call immediately or wait for your contact to answer before transferring the call: *Transfer*

Transfer between two outside calls is not generally possible (depends on country concerned and system configuration).



## 2.26 Three-way conference with internal and/or external contacts (conference)

- During a conversation, a second call is on hold.
- *Conference (Confer)* >> You are in conference mode.

### 2.26.1 Cancel conference and return to first contact (if conference is active)

- *End conference (End conf)*

### 2.26.2 Hang up on all participants (if conference is active)

-  Hang up.
- You exit the conference.

### 2.26.3 After the conference, to leave your two contacts talking together

- *Transfer*
-  Hang up.

### 2.26.4 View information about the other people in the conference

-  Navigate between both call in progress tabs involved in the conference.

## 2.27 Talk simultaneously to more than 2 contacts

This feature depends on the system configuration. If necessary, contact your administrator.

You are in a conference call with 2 contacts. To add another participant to the conference:

- *Add*
- Dial the number of your contact (dial, directories, last numbers dialed...).
- Your contact answers.
- *Insert* >> You are on the line with the additional contact.

During a 3-way conference, you can add up to three additional participants.

## 2.28 Placing a call on hold (hold)

### 2.28.1 Exclusive hold



During a conversation, you wish to place the call on hold and recover it later, on the same telephone.

- During a conversation.
- Use one of the following:
  -  Select the incoming call icon.
  - *Put on hold*

>> Your call is placed on hold  .

### Recover the call on hold

Use one of the following:

- Hang up, your phone is ringing, then answer the call.
-   Select the call on hold icon from the conversation screen.
- Select the tab which is displaying the call on hold > *Retrieve*
- Press the Back/Exit key to display the Perso page > Select the call on hold.

## 2.28.2 Common hold

This feature depends on the system configuration. If necessary, contact your administrator.

Common hold allows to all sets in the same pick-up group to resume a call (internal or external) that has been put on hold by one of the members of that group.

Putting on common hold:

- During a conversation.
-  Press the Back/Exit key to display the Perso page.
- Press programmed key: *Comm hold* (by default).

Recover the call on hold from any sets defined in the same pick-up group (including your set):

- Recover the call on hold from any sets defined in the same pick-up group (including your set)
- Press programmed key: *Comm hold* (by default).

## 2.29 Placing an outside call on hold (parking)

You can place an outside call on hold and recover the call on another telephone:

- During a conversation.
- *Park the call*
- Enter the number of the parking destination phone.

Retrieve the call from the parking destination phone:

- Reach the 'Menu' page.
- *Settings > My services > Consult > Call pick up services > Park/retrieve call*

Retrieve the call from another phone:

- Reach the 'Menu' page.
- *Settings > My services > Consult > Call pick up services > Park/retrieve call*
- Enter the number of the parking destination phone.

This feature is accessible via a programmed key.

If the parked call is not recovered within a preset time (default value 1 min 30), it is transferred to the operator.

## 2.30 Intrusion into an internal conversation (barge-in)

Your contact's line is busy. If the number is not 'protected' and if authorised, you can intrude into the call:

- *Intrusion*
- Same key to exit (*Intrusion*).

### 2.30.1 Protect a call against intrusion

- Press programmed key. The programmed key has to be configured by the system: *No intrusion (No intrud)* (by default).
- Enter contact's number.

Protection is cancelled when you hang up.

## 2.31 Signal malicious calls

This key lets you signal a malicious call. If this call has an internal source, it is signalled to the system by a special message.

- You receive a malicious call.
- *Malicious*

## 2.32 Recording the current conversation

The visibility of this feature depends on the system configuration managed by your administrator.

When you are on a call with one or more callers, you can record the conversation. At the start or end of recording, your caller hears a beep.



The user must have the appropriate rights to use this feature. Recorded conversations will then appear as voicemails.

To record the conversation during communication:

- *Record >>* Start recording.
- Recording in progress
  - *Restart rcrd >>* To restart recording.
  - *Stop rcrd >>* To stop the recording.
  - *Pause >>* To pause recording.
  - *Resume rcrd >>* To resume recording.

## 2.33 Forwarding calls to another number (immediate forward)

The number can be your home, mobile, voice mailbox or an internal extension (operator, etc.).



- Select the forward icon (the icon depends on your phone:  / .
- *Immediate forward (Immediate / Imm fwd / Immediate fwd)*
- Number to be called >> Forward is acknowledged.
- 

You can make calls, but only the destination number can call you.

If the associated number is defined, you can directly select it as the forwarding destination.

## 2.34 Forwarding calls if you do not answer or if you are busy

When you are absent or already in communication (all lines are busy), all your calls are forwarded to the defined number.

- Use one of the following:
  - Select the forward icon (the icon depends on your phone:  / .
  - Reach the 'Menu' page > *Forward*
- *Other forward (Other fwd)*
- Select the forward type to program.
  - *Forward on busy*
  - *Forward on no reply*
  - *Forward on busy/no reply*
- Number receiving forward >> Diversion is acknowledged.



If you have a key programmed with this feature, you can access the feature directly.

- Press programmed key.
- Number receiving forward >> Diversion is acknowledged.

If the associated number is defined, you can directly select it as the forwarding destination.



## 2.35 Do not disturb

You can make your terminal temporarily unavailable for all calls.

- Select the forward icon (the icon depends on your phone:  / .
- *Do not disturb (Not disturb)*
- Enter code to activate the feature.
- *Apply* >> Forward is acknowledged.
- 

Callers wishing to contact you will see the 'Do Not Disturb' message displayed on their sets when they try to call.

To deactivate the Do not disturb feature:

- Select the forward icon (the icon depends on your phone:  / .
- *Deactivate DND (Deact DND)*
- 



## 2.36 Forwarding calls to your pager

Callers will thus be able to contact you while you are moving around the company

- Press programmed key (the programmed key has to be configured by the system) >> Forward is acknowledged.



## 2.37 Forwarding your calls from the receiving terminal ('Follow me')

You wish to receive your calls in your present location: Use the 'Follow me' function.



- Select the forward icon (the icon depends on your phone:  / .
- *Other forward (Other fwd) > Remote forward*
- Enter the number of the phone you want to receive calls.
- Enter the number of the phone you want to forward calls >> Forward is acknowledged.

If you have a key programmed with this feature, you can access the feature directly.  
If the associated number is defined, you can directly select it as the forwarding destination.



### Cancel call forwarding from the forwarding phone

- Select the forward icon (the icon depends on your phone:  / .
- *Deactivate*

### Cancel call forwarding from the destination phone

- Select the forward icon (the icon depends on your phone:  / .
- *Other forward (Other fwd) > Deactivate follow me*
- Enter the forwarded phone number.

### Cancel call forwarding from an another terminal in your system

- Select the forward icon (the icon depends on your phone:  / .
- *Other forward (Other fwd) > Deactivate remote forward*
- Enter the forwarded phone number.



## 2.38 Applying a selective forward

You can forward your primary number and your secondary number or numbers to different sets.

- Reach the 'Menu' page.
- *Settings > My services > Consultation (Consult) > Forward services*
- Select the forward type to program.

- *Immediate forward*
- *Forward on busy*
- *Forward on no reply*
- *Forward on busy/no reply*
- Select the number to forward
  - *Principal line selection*
  - *Second line selection*
- Number receiving forward.
- 

## 2.39 Cancelling all forwards

- Use one of the following:
  - Select the forward icon (the icon depends on your phone:  / ).
  - Reach the 'Menu' page **»** *Forward*
- *Deactivate* **»** *Deactivate forward*

To cancel all forwards, you can programme another type of forward too.

## 2.40 Leaving a text message for internal callers

You can leave a text message on your terminal which will be displayed on the screen of the terminal calling you.

**123<>abc:** If your set is not provided with a magnetic keyboard, use the alpha-numeric keyboard to enter letters. You have to switch the keyboard to the alphabetic mode by selecting the associated programmed key. When activated, the LED corresponding to the key remains lit up.

- 
- *Text mail /New text message / x New text messages*
- *Fwd to text*
- Choose the type of message.

### Sending predefined message

- *Predefined msg (Predefined)*
- Select a predefined message.
- *Apply*

### Sending a message to complete

- *To complete*
- Select a predefined message to complete.
- Complete your message.
- *Apply*

### Sending a new message

- *Msg to create (To create)*
- Write your message.
- *Apply*

### To deactivate the forward to text feature

- 
- *Text mail /New text message / x New text messages*
- *Deactfwdtext* **»»** The text message is displayed.
- *Deactivate*

## 3 'Meet me' conference

The 'Meet me' function is used to set up a conference with a maximum of 29 persons (maximum value is configured in OXE system, it can be 7, 15 or 29).

### 3.1 Initiate a 'Meet me' conference

In order for the participants to join the conference, you must first decide on a meeting time for the conference and send them the access code.

- Enter the 'Meet me' conference prefix. It is defined by the administrator during system configuration. If necessary you may need to contact your administrator.
- Enter the conference access code.

The conference is set-up. Participants must enter this access code to join the conference call. Send the conference call access code to the participants.

In case of network connected OXE systems, to initiate a 'Meet me' conference with a distant OXE system, you have to enter a phone number of distant OXE system after prefix, to locate the conference. For more information, contact your administrator.

### 3.2 Join a 'Meet me' conference

Once set-up by the conference initiator, other participants can join the 'Meet me' conference.

- Enter the joining code for the 'Meet me' conference. This code is defined by the administrator during system configuration. If necessary you may need to contact your administrator.
- Enter the conference access code.  
Conference access code: 'x' digits code defined by the conference master and communicated to the participants so that they can join the conference.
- You are in conference mode.

An audible beep sounds when a participant joins the conference.

You cannot join a conference if there are already the maximum number of participants.

If you cannot directly reach the conference, you have to call first an internal user or an Attendant Set. This one dials the call number for joining the 'Meet-me' conference and then transfers your call (10 seconds).

## 4 Sharing

### 4.1 Answering the general bell

When the operator is absent, outside calls to the operator are indicated by a general bell. To answer:

- Reach the 'Menu' page.
- [Settings](#) › [My services](#) › [Consultation](#) › [Call pick up services](#) › [Night service call pick up](#)

### 4.2 Manager/Assistant filtering

System configuration allows 'Manager/Assistant' groups to be formed, so that the manager's calls can be directed to one or more assistants.

The programmed key has to be configured by the system.

#### From the manager or assistant telephone

- Press programmed key >> Incoming calls are filtered by a chosen person (assistant, etc.).
- Same key to cancel.

Filtering is indicated on the manager's telephone by the icon corresponding to the 'screening' programmed key.

### 4.3 Call pick-up

You hear a telephone ringing in an office where no-one can answer. If authorised, you can answer the call on your own telephone.

The system can be configured to prevent call pick-up on certain telephones.

#### If the telephone ringing is in your own pick-up group

- Reach the 'Menu' page.
- [Settings](#) › [My services](#) › [Consultation](#) › [Call pick up services](#) › [Group call pick up](#)

This feature is accessible via a programmed key: [Grp pick up \(GpPickUp\)](#) (by default).

#### If the telephone ringing is not in your pick-up group

- Reach the 'Menu' page.
- [Settings](#) › [My services](#) › [Consultation](#) › [Call pick up services](#) › [Individual call pick up](#)
- Number of telephone ringing

This feature is accessible via a programmed key: [Call pick up \(Pick up\)](#) (by default).

## 4.4 Hunting groups

### Hunting group call

Certain numbers can form a hunting group and can be called by dialling the group number.

### Temporary exit from your hunting group

- Reach the 'Menu' page.
- [Settings](#) › [My services](#) › [Consultation \(Consult\)](#) › [Additional services](#) › [Leave hunting group](#)
- Enter your group number

This feature is accessible via a programmed key: [Out of grup \(Out grp\)](#) (by default).

### Return into your group

- Reach the 'Menu' page.
- [Settings](#) › [My services](#) › [Consultation \(Consult\)](#) › [Additional services](#) › [Go into hunting group](#)
- Enter your group number.

This feature is accessible via a programmed key: [Into group \(In group\)](#) (by default).

Belonging to a group does not affect the management of direct calls. A specific telephone within a group can always be called by using its own number.

## 4.5 Calling an internal contact on his/her pager

The number called does not answer and you know that the person called has a pager:

- Dial the destination number.
- [Paging](#)
- Dial the destination number ›› Paging in progress is displayed.

Your contact can answer from any telephone in the system.

## 4.6 Answering a call on your pager

A call on your pager can be answered from any telephone within the system.

- Your pager beeps.
- Reach the 'Menu' page.
- [Settings](#) › [My services](#) › [Consultation \(Consult\)](#) › [Paging services](#) › [Paging answer](#)
- Your extension number.

This feature is accessible via a programmed key: [Pagng answ \(PagAnsw\)](#) (by default).



## 4.7 Calling a contact on his/her loudspeaker

Your internal contact does not answer. If authorised, you can remotely activate her/his phone:

- Your contact does not reply.
- *LS announce (Announce)* >> You are connected to the loudspeaker on your contact's phone (if he/she has the hands-free function).

## 4.8 Broadcasting a message on the loudspeakers of a station group

A message not requiring an answer can be broadcasted on the loudspeakers within your broadcast group:

- Off hook.
- Number of broadcast group >> Speak, you have 20 seconds.
-  Hang up.

The message will only be broadcast on terminals not in use and which have a loudspeaker.

## 5 Managing your charges

---

### 5.1 Charging your calls directly to business accounts

You can charge the cost of your outside calls to business account numbers.

- Reach the 'Menu' page.
- [Settings](#) › [My services](#) › [Consultation](#) › [Additional services](#) › [Business account code](#)
- Number of business account.
- Number required.

### 5.2 Finding out the cost of an outside call made for an internal user from your terminal

- Reach the 'Menu' page.
- [Settings](#) › [My services](#) › [Consultation](#) › [Consultation & callbacks](#) › [Charging informations](#)

# 6 Do more with your desk phone

Your desk phone is designed to evolve with its environment. It can do more than just establish communication between people or keep in touch with your contacts, your enterprise. This chapter describes some use-cases with your phone.

## 6.1 Use your desk phone as a USB audiohub for your computer

	8078s BT	8078s	8068s BT	8068s	8058s	8028s	8018	8008 8008G
This feature is supported by the following desk phones	●	●	●	●	●			

You have to use the ALE USB-A to USB C cable 3MG08020AA for PC connection to Deskphone to avoid any conflict with the Power over Ethernet.

Your phone can be used as a USB audiohub for audio calls and media when you connect it to a computer. Use the hands-free mode, the handset or the headset of your desk phone with applications such as Rainbow, OpenTouch Conversation for PC, Skype,... Or you can simply listen to music with an outstanding audio performance.

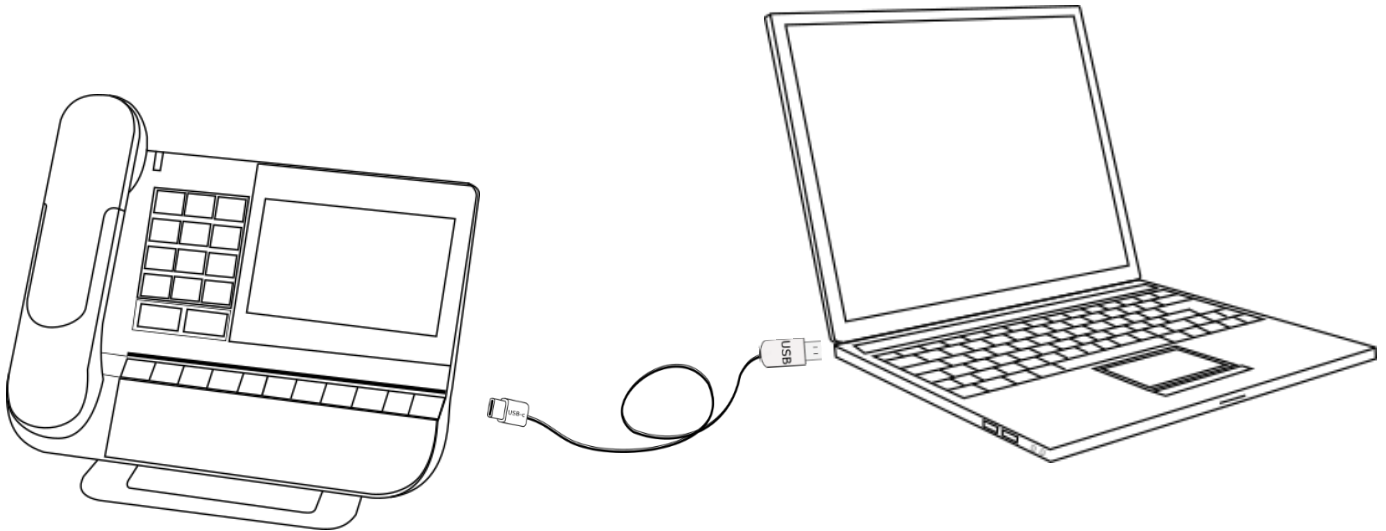

## 6.1.1 Installation

### Prerequisites

Before using your DeskPhone as a USB audiohub for your computer, make sure your computer meets the minimum hardware and software requirements.





The lists below are for information only and are not contractual. Contact your administrator if necessary.

- The supported operating systems are:

Windows	OS X	Linux
7 (32-bit or 64 bit) 8 (32-bit or 64 bit) 8.1 (32-bit or 64 bit) 10 (32-bit or 64 bit)	10.9 (Maverick) 10.10 (Yosemite) 10.11 (El Capitan) 10.12 (Sierra), 10.13 (High Sierra), 10.14 (Mojave), 10.15 (Catalina)	Compatible with most Linux distributions.

- USB connector: we recommend a USB 3.0 port (USB 2.0 or 1.0 port can reduce performance).
- We recommend using the latest version of audio applications or web browser.

### Connect your computer to your desk phone

- Configure your desk phone to use it as an audiohub (in case of the following icon is not displayed on the status bar: )
  -  Or  (long 'etat' press) **> AudioHub > USB**
  - Select the option: **USB Link**
  - The desk phone is ready to be connected to a computer. The following icon is displayed on your desk phone (light color): 
- Connect your computer to the USB-C connector of your desk phone with the USB cable (not provided). You have to use the ALE USB-A to USB C cable 3MG08020AA for PC connection to Deskphone to avoid any conflict with the Power over Ethernet. The phone is recognized as a sound device on computer (for example 'Echo cancelling speakerphone' with Windows). When computer is on, the following icon is displayed darker on your desk phone (dark color): 
- Your desk phone is ready to be used as an audiohub:
  - Use it as an audio extension (hands-free, handset or headset) to facilitate calls managed from your computer.
  - Use it to listen to music. Your desk phone switches automatically to music mode.

## Set the default audio device for Windows

- Open the sound control panel by right-clicking on the Sound icon from the Windows notification area.
- In the 'Playback' tab:
  - Set your desk phone as the default Communication Device if you are using it for audio calls.
  - Set your desk phone as the default device if you are using it to listen to music.

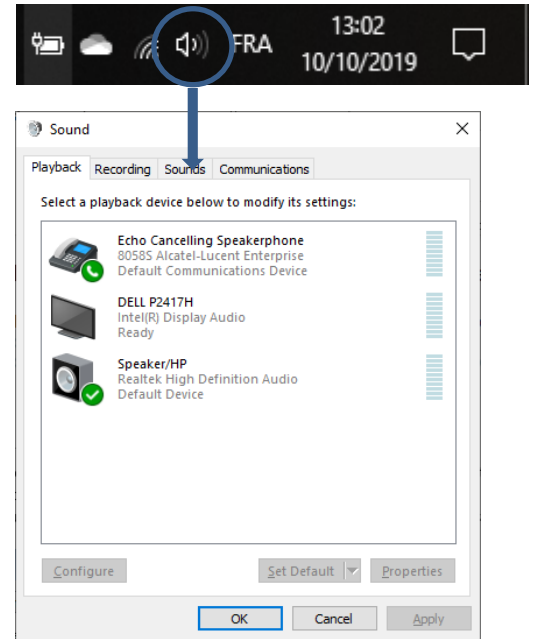

## Activating/Deactivating the sounds

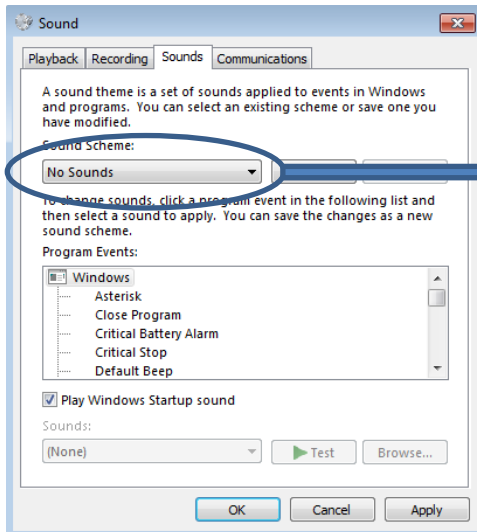

If you set your desk phone as the default audio device, all of the sounds from your computer are played on your desk phone, like notifications.

1. Activating/Deactivating the sounds.
2. Apply.

Consult the user manual of the operating system of your computer.

We recommend that you check that the desk phone you are using to make / receive calls on your computer is the audio media defined in the application.

### 6.1.2 Use your desk phone as an audiohub (hands-free mode, handset and headset)

The desk phone must be configured on your computer as the default 'communication' device from the 'sound' panel. Consult the user manual of the operating system of your computer.



#### Making a call

Use the application on your computer to make calls (consult the manual of the application for more details). The call is automatically established in hands-free mode on your desk phone.

#### Receiving a call

When you receive a call via your computer, a pop-up is displayed on the computer and the desk phone rings.

Use one of the following:





- Answer the call from your desk phone:
  - Take the handset of your desk phone off the hook. You are in conversation via the handset of your desk phone.
  -  Press the 'take the call' key to take the call in hands-free mode
  -  Press the loudspeaker/hands-free key to take the call in hands-free mode.
  - *Answer call ?*: Take the call with the headset if connected, or in hands-free mode.
- Take the call from the computer. The call is automatically established in hands-free mode on your desk phone.

When you are in hands-free mode, you can switch to the connected headset by pressing the loudspeaker/hands-free key (see below).



The media used to answer the call is displayed a few seconds on the screen when you receive the call or when you switch between hands-free, handset and headset during a conversation.

#### During conversation, from your desk phone, you can:

-  Mute the micro so that your contact can no longer hear you (the mute key blinks).
-  Turn down the volume.
-  Turn up the volume.
-  Switching between audio modes (see below).
- *Silence* When this option is selected, the audio of the desk phone is muted but the microphone remains activated.



## Switching between audio modes

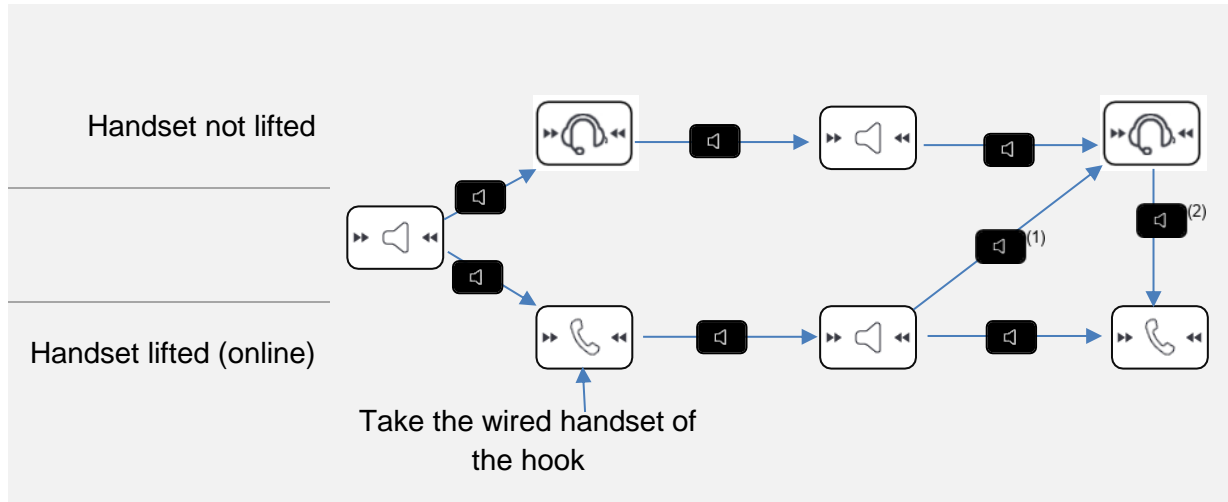

During conversation, you can switch between hands-free, handset and headset by pressing the loudspeaker/hands-free key briefly until the desired audio mode is displayed: .





(1) If the headset is connected (2) If the handset is already unhooked.

You are in conversation in hands-free mode and you want to switch to the handset:



- Use one of the following:

- Take the handset off the hook .
- If the handset is already unhooked:  Short press .



You are in conversation in hands-free mode and you want to switch to the connected headset:

-  Short press .

You are in conversation via the handset or headset and you want to switch to hands-free:

-  Short press  You are in hands-free mode. Associated light is lit.

## Release the call

- Use one of the following:
  - End the call from the application on your computer.
  - If you are using a wired handset, hang it up.
  - If you are using a wireless handset, hang it up.
  - .
  - If you are using the headset in a conversation, switch to hands-free by pressing the loudspeaker/hands-free key and end the conversation by pressing the hang up key:   
.

When you are using your desk phone as an audiohub, you cannot receive a call on the desk phone. The caller will see your phone as busy.

### 6.1.3 Use your desk phone to listen to music

The desk phone must be configured on your computer as the default device from the 'Sound' panel. Consult the user manual of the operating system of your computer.



You can use the HD audio quality of your phone to listen to music.





## 6.2 Use your desk phone as a Bluetooth® audiohub with your mobile phone (hands-free mode, handset and headset)

You can connect your mobile phone to your desk phone to use it as a Bluetooth® audiohub. You can use your desk phone (hands-free mode, handset or headset) to make and receive call from your mobile phone. A specific ringing of your desk phone is used when you receive a call from your mobile phone. A Bluetooth® connection is needed to place and receive your mobile calls on your desk phone. Access directly to the contacts directory and call log of your mobile phone from your desk phone. This feature is only available with compatible Bluetooth® desk phone.

### 6.2.1 Pair and connect your mobile phone to your desk phone

- Activate the Bluetooth® on your mobile phone. This procedure depends on your mobile phone. Please, consult the relevant user manual
-  In idle state, long press the hands-free key.
  - If no device are currently paired, a popup is displayed with the name and the MAC address (6 last characters) of your desk phone.
    - Wait, then select your desk phone on available Bluetooth® equipment listed on your mobile phone (Bluetooth® parameters).
    - Check that the same pairing code is displayed on the two devices.
    - Accept the pairing on your mobile phone.
    - **Yes:** accept the prompt for pairing your desk phone with the mobile.
    - Depending on your mobile phone, if you want to access to your contacts directory and the call log of your mobile from your desk phone, you have to accept to share contacts and/or call log ether during pairing, ether in connection options. Consult the user manual of your mobile phone.
    - : this icon is displayed on your desk phone. Your desk phone is ready to be used as a Bluetooth® audiohub
  - If your mobile phone is paired but not connected, your mobile phone is directly connected and the audiohub application is displayed.
  - If another device is currently paired, you have to unpaired it first (see chapter: Removing a Bluetooth® accessory (headset, handset, etc.))

You can also use the classic method to paired a Bluetooth® device:

- Activate the Bluetooth® on your mobile phone. This procedure depends on your mobile phone. Please, consult the relevant user manual
- Pair your desk phone as a Bluetooth® device
  - Use one of the following:
    -  (this icon is only available on the 8078s Premium DeskPhone).
    -  (long 'etat' press) › **Bluetooth®**
  - **Search devices**

›› Searching for Bluetooth® equipment. Wait for your mobile phone to be displayed on the desk phone.

- Select the relevant equipment.
- **Add**
- **Yes:** accept the prompt for pairing your desk phone with the mobile.
- Accept the pairing on your mobile phone.
- Depending on your mobile phone, if you want to access to your contacts directory and the call log of your mobile from your desk phone, you have to accept to share contacts and/or call log ether during pairing, ether in connection options. Consult the user manual of your mobile phone.

- : this icon is displayed on your desk phone. Your desk phone is ready to be used as a Bluetooth® audiohub.



### 6.2.2 Automatic reconnection of your mobile

Once your mobile has been connected to your desk phone, and depending on the configuration of your desk phone, your mobile will automatically connect to the desk phone when you are nearby.

-  In idle state, with a connected mobile phone, press and hold the hands-free key.
- *Auto reconnect*  
Select this option to automatically reconnect your mobile to your desk phone.
- *Reconnect range*  
Set the range from which your mobile attempts to connect to your desk phone (*Near, Mid, Far*).

### 6.2.3 Define the specific ringing for incoming calls

When you receive an incoming call on your mobile phone, the desk phone will use the specific ringing.

-  In idle state, with a connected mobile phone, press and hold the hands-free key.
- *Ringing*
- Select the ringing in the list.
- 

### 6.2.4 Meeting room

If the desk phone is located in a meeting room, to facilitate the pairing and unpairing of the mobile phone, we recommend enabling the following option: *Shared phone*.

-  (long 'etat' press) › *Audiohub* › *Bluetooth®*
- Enable the option: *Shared phone*

In this case, if a mobile phone is paired with the desk phone, a popup lets you choose to connect the current paired mobile phone or to paired a new one.





-  In idle state, long press the hands-free key.
- If a mobile phone is paired but not connected:
  - *Yes*: connect the current paired mobile phone.
  - *Unpair*: unpaired the mobile phone and launch the procedure to paired a new one.

### 6.2.5 Consult the call log of your mobile phone

At any time, you can consult all answered and unanswered incoming and outgoing calls. To do this, open the call log of your mobile phone directly from your desk phone.

This feature is available if you have accepted to share contacts and/or call log.

-  In idle state, with a connected mobile phone, press and hold the hands-free key.
- *Call log*  
All incoming, outgoing, missed or unanswered calls are displayed in the call log.

	Unanswered outgoing calls
	Answered outgoing calls.
	Unanswered incoming calls.
	Answered incoming calls.



### 6.2.6 Consult the contacts directory of your mobile phone

You can consult the list of up to 500 contacts stored in your mobile phone.

-  In idle state, with a connected mobile phone, press and hold the hands-free key.
- *Contacts*  
Your mobile contacts are sorted alphabetically by name and grouped according to the first letter of the name.
- Select an alphabetical group containing your contact.
- Use navigation keys to browse the list.
- Open the contact detail by selecting the contact in the list (tap the name or press the corresponding right or left key).

### 6.2.7 Making a call

Use one of the following:



- Use your mobile phone to call a contact. If necessary, select your desk phone in the list of available devices displayed on your mobile phone to make the call. The call is automatically established in hands-free mode on your desk phone.
- Dial the number from the desk phone
  -  In idle state, with a connected mobile phone, press and hold the hands-free key.
  - *Dialpad*
  - Dial the number to call.
  - *Dial*
  - The call is established using your mobile phone. The call is automatically established in hands-free mode on your desk phone.
- Use the contact directory of your mobile phone from your desk phone (this feature is available if you have accepted to share contacts and/or call log)
  -  In idle state, with a connected mobile phone, press and hold the hands-free key.
  - *Contacts*  
Your mobile contacts are sorted alphabetically by name and grouped according to the first letter of the name.
  - Select an alphabetical group containing your contact.
  - Use navigation keys to browse the list.

- Open the contact detail by selecting the contact in the list (tap the name or press the corresponding right or left key).
- All available numbers are displayed. Select the desired number to make the call.
- The call is established using your mobile phone. The call is automatically established in hands-free mode on your desk phone.
- Use the call log of your mobile from your desk phone (this feature is available if you have accepted to share contacts and/or call log)
  -  In idle state, with a connected mobile phone, press and hold the hands-free key.
  - *Call log*  
All incoming, outgoing, missed or unanswered calls are displayed in the call log.
  - Use navigation keys to browse the list.
  - Open the contact detail by selecting the contact in the list (tap the name or press the corresponding right or left key).
  - *Redial*
  - The call is established using your mobile phone. The call is automatically established in hands-free mode on your desk phone.

### 6.2.8 Receiving a call





When you receive a call on your mobile, a pop-up is displayed on the desk phone to invite you to take the call.

Use one of the following:

- If you are using a wired handset, you can take it directly off the hook to take the call.
- If you are using a headset, use the off hook key of the headset to take the call.
- *Take call*: select this softkey on the desk phone to take the call in hands-free mode.
- : press the 'take the call' key to take the call in hands-free mode.
- : press the loudspeaker/hands-free key to take the call in hands-free mode.
- *Decline call*: forward the incoming call to the mobile phone voicemail.

You can always answer the incoming call with your mobile phone, to use it for the conversation. In this case, the audio is managed by the mobile phone. You can only release the call from the desk phone.

### 6.2.9 During conversation

-  Mute key so that your contact can no longer hear you.
-  Turn down the volume.
-  Turn up the volume.
-  Switching between audio modes.

### 6.2.10 Switching between audio modes

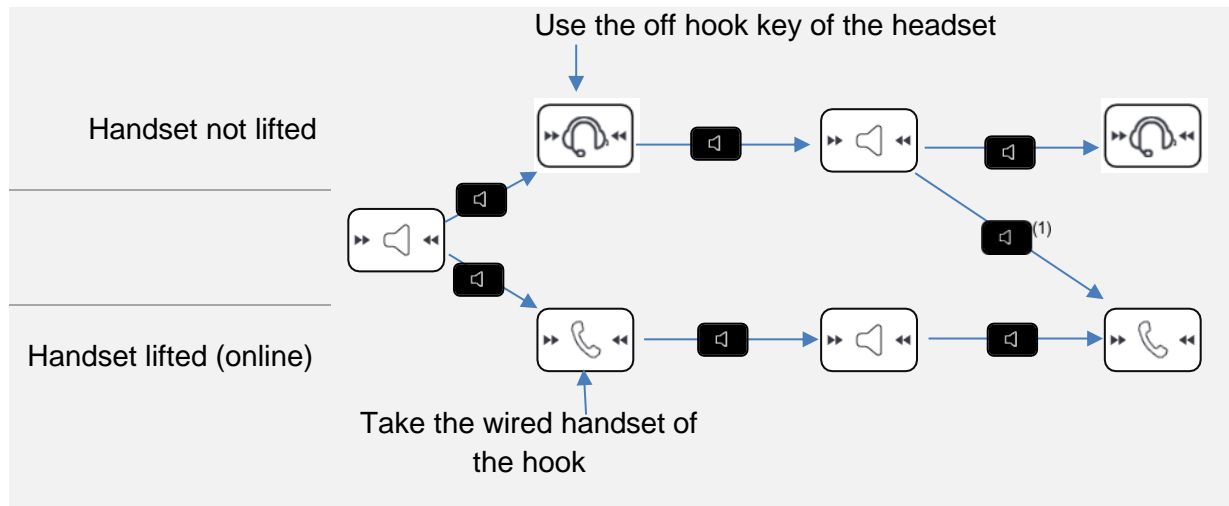

During conversation, you can switch between hands-free, handset and headset by pressing the loudspeaker/hands-free key briefly until the desired audio mode is displayed: .



<sup>(1)</sup> If the handset is already unhooked.

You are in conversation in hands-free mode and you want to switch to the handset:

- Use one of the following:

- Take the handset off the hook > .
- If the handset is already unhooked:  Short press > .



You are in conversation in hands-free mode and you want to switch to the connected headset:

- Use one of the following:

- Press the On-Hook/Off-Hook key on the headset > .
-  Short press > .

You are in conversation via the handset or headset and you want to switch to hands-free:

- Use one of the following:

- Hang-up the handset >  > You are in hands-free mode. Associated light is lit.
-  Short press >  > You are in hands-free mode. Associated light is lit.

### 6.2.11 Release the call

Use one of the following:

- End the call from your mobile phone.
- If you are using a wired handset, hang it up.
- If you are using a headset, use the hang up key of the headset to release the call.
- *Release call*: select this softkey on the desk phone.
- .

When you are using your desk phone as an audiohub, you cannot receive a call on the desk phone. The caller will see your phone as busy.

It is not possible to take the call directly with the Bluetooth® handset.

## 6.3 Configure your phone for remote working

Your IP phone is compatible with remote working (VPN) via a secure connection (encrypted). Your phone supports the IKEv1 and IKEv2 protocol to send data securely. In this mode, all features available at your office will be ready for use remotely.

If the telephone system of your enterprise is configured to accept remote workers (system and infrastructure), you have to configure your desk phone to be ready for remote working.

The configuration of the phone depends on the infrastructure of your telephony network.

For information, please consult the following guide:

- “IPsec VPN Deployment Guide for Remote Workers for DeskPhones and Premium DeskPhones s Serie “ 8AL90345ENAA (<https://businessportal.al-enterprise.com/8AL90345ENAA>)

In this section, we describe the complete configuration of your phone for remote working.

Your installer has to give you all information to configure your desk phone.

You have to:

- Enable VPN.
- Enter the remote VPN server information.
- Enter the TFTP server information (Optional).
- Enter authentication.
- Setup the VPN start preferences.

### 6.3.1 First connection as remote working

When you connect your desk phone for the first time remotely, you are prompted to set a PIN code. The PIN code is requested when you enter in the VPN configuration (submenu) or when you boot your desk phone (depending on the VPN configuration).





The PIN code is retained during the session so that you can access the VPN configuration without having to re-enter your PIN code until you exit the VPN configuration.

Before configuring your phone for remote working, check if you have all the information from your administrator.

**123<>abc**: If your set is not provided with a magnetic keyboard, use the alpha-numeric keyboard to enter letters. Use the alpha-numeric keyboard key to switch between the numeric and alphabetic keyboard. When in alphabetic mode, the LED corresponding to the key remains lit up.

To configure your desk phone:

- Connect your desk phone to the network (and plug in the power jack if you are using an external power adapter).
- When the desk phone displays the 'Step 2' during the boot, repeatedly press the '\*' and '#' keys in succession until a menu is displayed.
- **VPN** (scroll down the menu).
  - **VPN Config**
    - Enter the new PIN Code.
    -  Validate.
    - **Enable VPN**: you have to activate this option to use your desk phone for remote working.
    - **VPN Server**: enter the address of the VPN server.
    - **VPN PSK**: enter the pre-shared key to establish a secure connection with the VPN server. The PSK can be unique for all remote workers on a same installation or can be specific to each remote worker. In the first case, the VPN authentication has to be enabled.





- *IKE version*: Enter the IKV version (IKEv1/IKEv2) (IKEv1/IKEv2).
  - *VPN Tftp* › *Use TFTP servers, tftp1, tftp2, port*: if the TFTP servers are required, activate this option and enter the addresses and port of the TFTP servers.
  - *VPN Authent* › *Use Authentication, User, Password*: activate this option if a logon to the VPN server (username and password) is required. The VPN authentication can be disabled in case a specific PSK is used for each remote worker.
  - *VPN Pincod* › *Request Pincod on Boot*: if this option is activated, the PIN code is required when you boot your desk phone. We recommend you activate this option.
  -  Select this icon to return to the main menu.
  -  Select this icon to save parameters.
- The VPN configuration is saved and the main menu is displayed.
  -  Select this icon to exit the configuration menu. The desk phone restarts.
  - Enter the PIN code if you have selected the option (*Request Pincod on Boot*).
  -  Validate.
  - Your desk phone is ready for remote working.

If you leave the PIN code request menu when the phone is starting, the phone will start without VPN activated.

If an error occurs when your phone is running in remote mode, a popup is displayed with an error message. Please note this message to send to your administrator.

### 6.3.2 Change the configuration

You have to change a parameter of the VPN configuration.

- Restart the desk phone (unplug and plug in the power jack if you are using an external power adapter or the Ethernet connector – LAN).
- When the desk phone displays the 'Step 2' during the boot, repeatedly press the '\*' and '#' keys in succession until a menu is displayed.
- *VPN* (scroll down the menu).
- Select a submenu to change the configuration (*VPN Config, VPN Tftp, VPN Authent, VPN Pincod*).
- Enter your PIN code (If an administrator password is defined by the system, you can use it to access to the VPN configuration by selecting: *Use Password*).
-  Validate.
- Change parameters.
-  Select this icon to save parameters.
- The VPN configuration is saved and the main menu is displayed.
-  Select this icon to exit the configuration menu. The desk phone restarts.
- Enter the PIN code if you have selected the option (*Request Pincod on Boot*).
-  Validate.
- Your desk phone is ready for remote working.

If an error occurs when your phone is running in remote mode, a popup is displayed with an error message. Please note this message to send to your administrator.





### 6.3.3 PIN code

The PIN code is composed of 4 digits. You can access the VPN configuration by entering the PIN code or the administrator password if defined by the system. Depending on the VPN configuration, the PIN code is requested when you boot your desk phone. We recommend you enable this option for security reasons and if you need your phone in remote and in business place (See Reconnect your desk phone in your business place).

If the PIN code is incorrect 5 times in succession, the PIN code and VPN parameters will be erased. If no administrator password is defined by the system, the PIN code is required to access VPN configuration.





Once the PIN code and the administrator password have been set, you can switch between the PIN code and the administrator password by selecting the following softkeys in the login window: *User password*, *Use PIN code*.

### 6.3.4 Reset your PIN code

- Restart the desk phone (unplug and plug in the power jack if you are using an external power adapter or the Ethernet connector – LAN).
- When the desk phone displays the 'Step 2' during the boot, repeatedly press the '\*' and '#' keys in succession until a menu is displayed.
- *VPN* (scroll down the menu).
- *VPN Pincod*
- Enter your PIN code.
-  Validate.
- *Set new Pincod*: enter the new PIN Code.
-  Select this icon to save parameters.
- The VPN configuration is saved and the main menu is displayed.
-  Select this icon to exit the configuration menu. The desk phone restarts.
- Enter the PIN code if you have selected the option (*Request Pincod on Boot*).





### 6.3.5 Reconnect your desk phone in your business place

Your phone is already configured for remote working.

- Connect your desk phone to the network (and plug in the power jack if you are using an external power adapter).
- If the option to enter PIN code when you boot your desk phone is enabled in the VPN configuration (*Request Pincod on Boot*):
  - The PIN code is requested.
  -  Select this icon to go back.
  - The phone restarts in normal mode. The VPN is temporary disabled until the next reboot.
- If the option is not enabled:
  - When the desk phone displays the 'Step 2' during the boot, repeatedly press the '\*' and '#' keys in succession until a menu is displayed.
  - *VPN > VPN Config*
  - Enter your PIN code.
  -  Validate.
  - *Enable VPN*: disable the teleworker.
  -  Select this icon to save parameters.
  - The VPN configuration is saved and the main menu is displayed.
  -  Select this icon to exit the configuration menu.
  - The phone restarts in normal mode.

### 6.3.6 Reconnect your desk phone in remote place

Your phone is already configured for remote working but it was connected in your place of business. You need to reconnect it in a remote place.

- Connect your desk phone to the network (and plug in the power jack if you are using an external power adapter).
- If the option to enter PIN code when you boot your desk phone is enabled in the VPN configuration (*Request Pincode on Boot*):
  - The PIN code is requested.
  - Enter PIN code.
  -  Validate.
  - The phone starts as teleworker.
- If the option is not enabled (*Request Pincode on Boot*).
  - When the desk phone displays the 'Step 2' during the boot, repeatedly press the '\*' and '#' keys in succession until a menu is displayed.
  - *VPN > VPN Config*
  - Enter your PIN code.
  -  Validate.
  - *Enable VPN*: enable the teleworker.
  -  Select this icon to save parameters.
  - The VPN configuration is saved and the main menu is displayed.
  -  Select this icon to exit the configuration menu.
  - The phone starts as teleworker.

If an error occurs when your phone is running in remote mode, a popup is displayed with an error message. Please note this message to send to your administrator.

## 6.4 Beacon: using your desk phone for geo-localization in the enterprise

	8078s BT	8078s	8068s BT	8068s	8058s	8028s	8018	8008 8008G
This feature is supported by the following desk phones	●	●	●	●	●	●	●	

Your desk phone can behave as a beacon, by periodically emitting data, using BTLE (Bluetooth Low Energy) technology.

A beacon is a small Bluetooth® radio transmitter. it repeatedly transmits a single signal that other devices can use. A Bluetooth-equipped device like a DECT or a smartphone, can detect a beacon once it's in range.

There are many applications for localization with beacon. For example, isolated worker protection is becoming more and more a concern for companies. But an infrastructure is necessary to locate device used by the worker inside the enterprise, and can be expensive. Therefore, the enterprise can use each desk phone in the site to create an infrastructure of beacons.

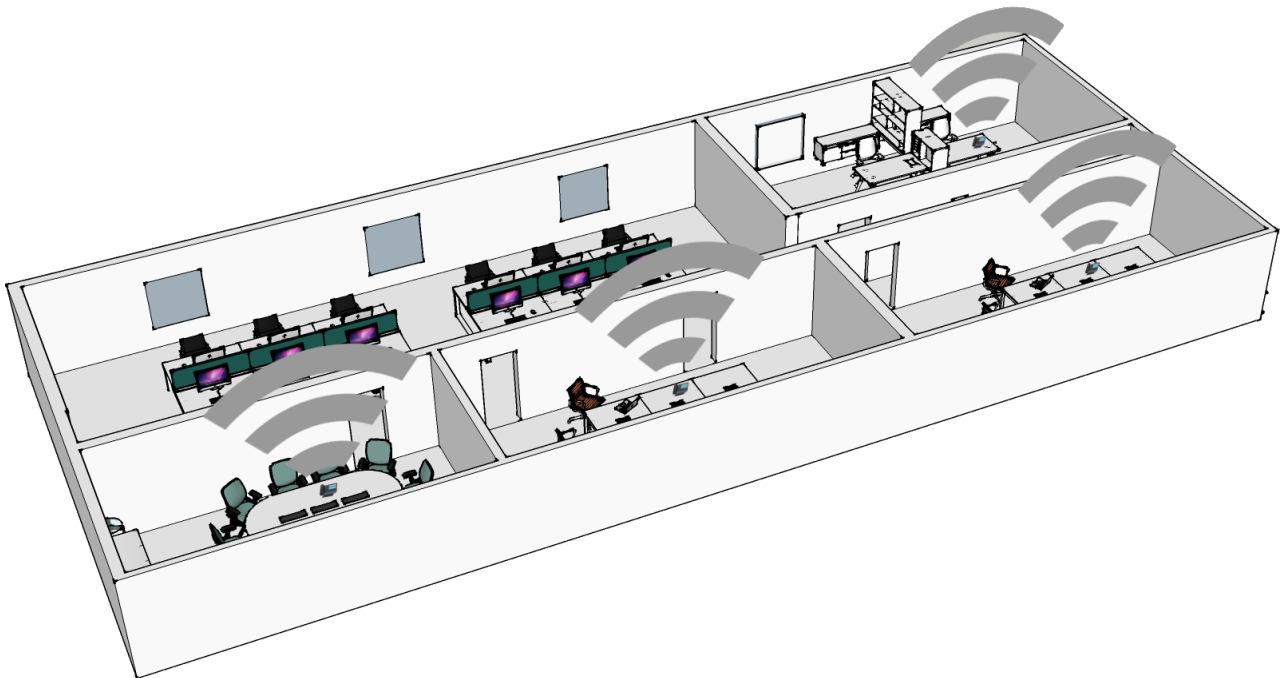

The 8078s and 8068s Premium DeskPhones have a built-in beacon (8078s BT, 8068s BT, 8078s, 8068s).

For the other phones, you can use a specific dongle (Dongle USB OmniAccess Stellar BLE, Same dongle used for: OmniAccess Stellar Access Points; See chapter: 11.1 List of accessories). The dongle can be plugged into the phone to have a full range BTLE (Bluetooth Low Energy) feature for localization. No configuration is required- Just plug the dongle into the USB-a connector.

Your administrator can enable or disable the built-in 8078s, 8068s Bluetooth® DeskPhone beacon (see: 7 Contacting your administrator).

If you are using a Bluetooth® handset or headset, the beacon integrated into the 8078s, 8068s Bluetooth® Premium DeskPhone will not emit data when you are in conversation until the call is ended. The dongle can be connected to the 8078s, 8068s Bluetooth® Premium DeskPhone. In this case data will be emitted even if you are in conversation.

## 6.5 Visual Notification Assistant (VNA)

The purpose of the VNA feature is to allow instant distribution of an audio message (notification) to all members of a group (large or not) defined by the administrator. Your desk phone can be used to broadcast an urgent message to the greatest number of employees. The broadcasted audio message will be played instantly and simultaneously on each phone. This feature depends on the phone configuration and the company infrastructure.

Two modes can be configured by the administrator depending on the working environment:

- Loud:
  - You are alerted of the incoming notification by the pop-up window displayed on the screen. The pop-up window indicates the active device which will be used to play the notification.
  - The notification is played on the phone loudspeaker. The message volume is higher than the volume you set in the phone settings (level + 2).
  - After the notification, the phone returns to its initial state.
- Discreet:
  - You are alerted of the incoming notification by the pop-up window displayed on the screen and the audio signal (beep), asking to select the device to use to listen to the notification (handset, headset or loudspeaker). The pop-up window indicates the active device which will be used to play the notification.
  - The notification is played on the selected device or the active device if you are in conversation. In case of hands-free, you can select the device to listen the notification. The defined volume in the phone settings is used.
  - After the notification, the phone returns to its initial state.



If you are in conversation, the local and distant audio call are muted while the notification is playing. You recover your call after the notification if the call is still active.



You can interrupt the notification to make for example an emergency call by pressing twice on the release key. First press, a pop-up window is displayed asking you to confirm the action by pressing again the release key.

## 6.6 EHS (Electronic Hook Switch)



	8078s BT	8078s	8068s BT	8068s	8058s	8028s	8018	8008 8008G
This feature is supported by the following desk phones	●	●	●	●	●	●		

Your phone allows you to connect a wide range of accessories. The EHS feature allows compatible accessories to retrieve status information of the desk phone (ringing, in communication) but also to control it (take or end a call).

This feature is useful when you are using accessories like headset or conference module with on-hook/off-hook buttons, DECT base station with its associated DECT headset,...

Depending on the accessory and the connector used, you have to configure the integrated EHS to use accessory better. By default, all options are disabled.

Access to the EHS configuration:

-  Or  (long press) › [Audiohub](#)
- [EHS](#)

Here are some examples of EHS options to activate depending on the connected accessory and the desired feature:

- Use the on-hook/off-hook button of a headset compatible with Android mobile connected to the jack connector of your desk phone: [Android](#) (conform to Android specification: <https://source.android.com/devices/accessories/headset/jack-headset-spec>).
- Hear the ringing in the device (headset for example) connected to the jack connector: [Jack ring](#).
- Use an external ringer connected to the SATA connector: no activated option.
- Use a busy lamp connected to the SATA connector: no activated option.
- Use a wireless DECT headset connected to the jack connector: [ACOM jack only](#).

# 7 Programming your telephone

## 7.1 Initializing your voice mailbox

- Light flashes.
- 
- Enter your personal code then record your name according to voice guide instructions.

Your personal code is used to access your voice mailbox and to lock your telephone.

A weak personal code will be rejected by the system:

- Identical 4 digits (0000, 1111,).
- A simple sequence of 4 digits (0123, 1234,).

Make sure you choose a strong password with at least 4 digits. The list of weak passwords provided does not contain all the possibilities.

## 7.2 Customizing your voice greeting

You can replace the greeting message by a personal message.

- 
- *Voice mail / New voice message / x New voice messages*
- Enter your personal code.
- *Perso options › Greeting msg › Perso greeting ››* Record message.
- *End ››* End of recording.
- Use one of the following:
  - *Accept ››* Apply.
  - *Restart ››* Re-record a message.
  - *Replay ››* Replay message.

To return to the default message.

- *Normal prompt*

## 7.3 Modify the password for your phone set

- Reach the 'Menu' page.
- *Settings › Phone › Password*
- Old code (4 digits).
- *Apply*
- New code (4 digits).
- *Apply*
- Enter new password again to confirm.
- *Apply*
- 



This code acts as a password controlling access to programming functions and the user 'Set Locking ' function (code by default: 0000).

A weak personal code will be rejected by the system:

- Identical 4 digits (0000, 1111,).
- A simple sequence of 4 digits (0123, 1234,).

Make sure you choose a strong password with at least 4 digits. The list of weak passwords provided does not contain all the possibilities.

## 7.4 Modify the password for your voice mailbox

- 
- *Voice mail / New voice message / x New voice messages*
- Enter your personal code.
- *Perso options > Password*
- New code (4 digits).
- *Apply*
- 

As long as your voice mailbox has not been initialized, personal code is 0000.

A weak personal code will be rejected by the system:



- Identical 4 digits (0000, 1111,).
  - A simple sequence of 4 digits (0123, 1234,).
- Make sure you choose a strong password with at least 4 digits. The list of weak passwords provided does not contain all the possibilities.

## 7.5 Adjusting the audio functions

- Reach the 'Menu' page.
- *Settings > Phone > Ringing*
- Enter your password (if required) and apply.





### 7.5.1 Choose the tune

The compatible desk phone offers a choice of key ringtones including 16 new Super Wide Band ringtones.

- Select the type of call to which the ringing is to be associated.
  - *Internal call (Internl call)*
  - *External call (Externl call)*
- Select the melody of your choice (32 tunes).
- 
-  End /  To adjust other audio features.



One ringing is louder than the others and can be used in noisy environments.

### 7.5.2 Adjusting the ringer volume



- *Level (Volume)*
-   Select the volume you want (10 levels).
-  End /  To adjust other audio features.

One ringing is louder than the others and can be used in noisy environments.



### 7.5.3 Activate/deactivate silent mode

- *More options*
  - *Silent mode >>* To activate.
  - *Silent mode >>* To deactivate.
-  End /  To adjust other audio features.



### 7.5.4 Activate/deactivate meeting mode (progressive ringing)

- *More options*
  - *Progressive ringing* >> To activate.
  - *Progressive ringing* >> To deactivate.
-  End /  To adjust other audio features.

### 7.5.5 Activate/deactivate discreet ring mode

- *More options*
  - *One beep before ringing* /  *Three beeps before ringing* >> To activate.
  - *One beep before ringing* /  *Three beeps before ringing* >> To deactivate.
-  End /  To adjust other audio features.



### 7.5.6 Adjust ringer volume while a call arrives

- Your telephone rings.
-   Adjusting the ringer volume.

## 7.6 Audio ambiances

Your desk phone provides 4 audio ambiances for a more personalized and enjoyable use. Depending on the selected ambience, the bass or treble will be more present, the range of frequencies used will be greater or less.



The audio ambience can be changed when the desk phone is in idle state or during a conversation (except if you are in conversation via the USB audiohub).

-  Or  (long press) > *Audiohub* > *Ambiances*
- Select the desired ambience.
  - *Neutral*: no filter.
  - *Bass Boost*: the bass feeling is reinforced.
  - *Clarity*: the treble are more present, the sound is clearer.
  - *Legacy*: the audio frequency range is reduced (for sensitive users at high or low frequencies).

The default ambience is: *Neutral*.

## 7.7 Hearing Aid

If you are using your phone with a hearing device, you must install and activate the hearing aid device (HAC) to avoid hearing discomfort.

-  Or  (long press) > *Audiohub* > *Hearing Aid*
- Check this option if you are using a hearing aid.

We recommend using the following ambience in this case: *Neutral*.



## 7.8 Adjusting the brightness of the desk phone (8078s, 8068s, 8058s, 8028s Premium DeskPhone)



Adjust the brightness of the display, the LEDs, the keys (add-on) and the logo light on the back shell (optional).

### 7.8.1 Auto-adjusting of the brightness

The phone can automatically adjust the display brightness, LED and busy light logo on the back shell (if present) depending on the lighting conditions to improve user experience and achieve power savings (ambient light sensor).

: This icon is only available on the 8078s Premium DeskPhone.







#### Auto-adjusting of the display brightness

-  Or  (long press) › *Display* › *Auto-Brightness*
- Activate or deactivate the feature.







#### Auto-adjusting of the LED brightness and the busy light logo on back shell (if present)

-  Or  (long press) › *Display* › *Advanced* › *LED Auto-Brightness*
- Activate or deactivate the feature.







### 7.8.2 Adjust the brightness when the phone is in use

-  Or  (long press) › *Display* › *Brightness*
-   Increase or decrease the brightness.
- 
- 

### 7.8.3 Adjust the dimmed brightness when the phone is not in use





-  Or  (long press) › *Display* › *Advanced* › *Low brightness*
-   Increase or decrease the brightness.
- 
- 

### 7.8.4 Set the delay before the brightness is dimmed when the phone is not in use (screensaver)

-  Or  (long press) › *Display* › *Screensaver*
-   Set the time delay (default 4 hours).
- 
- 



: This icon is only available on the 8078s Premium DeskPhone.

## 7.9 Adjusting the contrast of the display (8028s, 8018, 8008G, 8008)



- Reach the 'Menu' page.
- [Settings](#) › [Phone](#) › [Contrast](#)
-   Decrease or increase the contrast of the display. You can use also the dedicated function keys displayed on the screen.
- 
- 

## 7.10 Selecting the welcome page

This function is used to choose the page displayed by default on the telephone.

- Reach the 'Menu' page.
- [Settings](#) › [Phone](#) › [Homepage](#)
- Enter your password (if required) and apply.
- Select the default page (Menu, Perso, Info, Last page seen...).
- 
- 

## 7.11 Selecting language

- Reach the 'Menu' page.
- [Settings](#) › [Phone](#) › [Language](#)
- Enter your password (if required) and apply.
- Select the language of your choice.
- 
- 

## 7.12 Programming keys for call numbers and functions (Perso page/F1 and F2 keys/Add-on keys)

**123<>abc:** If your set is not provided with a magnetic keyboard, use the alpha-numeric keyboard to enter letters. Use the alpha-numeric keyboard key to switch between the numeric and alphabetic keyboard. When in alphabetic mode, the LED corresponding to the key remains lit up.

Depending on your desk phone, you can program:

- Softkeys of the Perso page.
- Keys/softkeys of the add-on module.
- F1 and F2 keys.
- Programmable keys with LED and paper.  
Led behavior may differ depending on the system configuration. For more information, contact your installer or administrator.

### If the key is not programmed yet:

- Select the key to program.
- Enter your password (if required) and apply.
- Use one of the following:
  - [Speed dial](#) ›› To program a number.
  - [Services](#) ›› To program a function.

**If the key is already programmed:**

- Use one of the following:
  - 
  - Reach the 'Menu' page › *Settings* › *Phone* › *Key program* › *Prog perso page*
- Select the key to program.
- Enter your password (if required) and apply.
- Use one of the following:
  - *Speed dial* ›› To program a number.
  - *Services* ›› To program a function.

**To program a number**

- *Speed dial*
- Enter the number.
- *Apply*
- For a softkey (perso page or add-on), enter the name of the key.
- *Apply*
- 



**To program a function**

- *Services* ›› Follow information displayed on the screen.
- 



**7.12.1 Other possibilities**

- *Modify* ›› Modify contents of entry displayed.
- *Erase* ›› Delete

**7.13 Modify a programmed key**

- Use one of the following:
  - 
  - Reach the 'Menu' page › *Settings* › *Phone* › *Key program* › *Prog perso page*
- Select the key to modify.
- Enter your password (if required) and apply.
- *Modify*
- 

**7.14 Delete a programmed key**

- Use one of the following:
  - 
  - Reach the 'Menu' page › *Settings* › *Phone* › *Key program* › *Prog perso page*
- Select the key to delete
- Enter your password (if required) and apply.
- *Delete (Clear)*
- 

## 7.15 Programming an appointment reminder

You can define the time of a temporary reminder (one in 24 hours).

- Reach the 'Menu' page.
- *Appointment (Appoint)*
- Enter time of appointment.
- Dial the number of the appointment destination set.



 The 'Appointment programmed' icon is displayed on the welcome page of the phone that will be alerted.

At the programmed time, your phone rings:

-  /  / 

If your calls are forwarded to another terminal, the forward is not applied to the reminder call.

To cancel your reminder request:

- Reach the 'Menu' page.
- *Appointment (Appoint) › Delete*



The 'Appointment programmed' icon disappears from the welcome page.

## 7.16 Call the associated set

The number of another set can be associated with your set number (See Modify the associated number).

To call it:

- Reach the 'Menu' page.
- *Settings › My services › Consultation (Consult) › Associate services › Call associate*

## 7.17 Forward your calls to the associated number

If you have previously defined an associated number, you can forward your calls to this number.

- Reach the 'Menu' page.
- *Settings › My services › Consultation (Consult) › Associate services*
- Use one of the following:
  - *Overflow to associate ››* For forwarding when you do not answer.
  - *Overflow if busy to associate ››* For immediate forwarding when your line is busy.
  - *Overflow busy/no rep to assoc ››* For forwarding if you do not answer or if you are busy.
  - *Deact overflow to associate ››* To cancel the forwarding to associate function.
- *Apply*



 : You can also use the forwarding service to forward your calls to the defined associated number.

## 7.18 Modify the associated number

The associated number can be a phone set number, the voice mail number or the pager number.

- Reach the 'Menu' page.
- *Settings* > *My services* > *Associate*
- Enter your password.
- *Apply*
- *Modify*
- Select the new associated number.
  - Enter the new associated number.
  - *Speed dial*

## 7.19 The Tandem configuration

This configuration lets you group sets under a single phone number. Your set is then the main set and the other sets, usually a DECT, a remote extension, a DeskPhone or softphone, are secondary sets. Each set has its own directory number, but the tandem number is that of the main set. When you receive a call, all sets ring simultaneously. When one of the sets answers, the other sets stop ringing. When all the lines of the main set are busy, the secondary sets did not ring. A secondary set can still be called by its own number, but in this case, the tandem function will no longer be taken into account. Most of the functions are common to all sets, for example: forwarding, meet-me reminder, the various messages, etc., while others are specific to each set, for example: individual directory, last number redial, out of service, locking, etc. Tandem mode supports up to 4 secondary devices.

For more information regarding this configuration, contact the person in charge of your installation.

## 7.20 Create, modify or consult your interphony list (max. 10 numbers)

- Reach the 'Menu' page.
- *Settings* > *My services* > *Interphony*
- Enter your password.
- Select an entry.
- Follow the on-screen instructions.

## 7.21 Install a jack accessory (headset, hands-free, loudspeaker) (8078s, 8068s, 8058s, 8028s Premium DeskPhone)

Your phone is equipped with a 3.5 mm, 4 pole jack. If your device is not compatible, you can use a 3 pole to 4 pole jack adapter.

### 7.21.1 Install the accessory

By default, the audio jack of your telephone can be used to connect a headset, hands-free kit or loudspeaker. A wideband headset can also be installed for optimized sound quality.



When you plug the jack accessory in the jack, a popup asks you for the type of accessory:

- *Headset*
- *Handsfree*
- *Loudspeaker*

If another headset is already connected (USB or Bluetooth® if available), a popup asks you to select your preferred headset.

A specific icon is displayed in the status bar: .

If necessary, you can also select the accessory type in the audio settings:



-  Or  (long press) › [Audio](#)
- [Jack config.](#)
- [Headset / Handsfree / Loudspeaker](#) › Select the type of device plugged into the jack.
- 

Your phone is equipped with a 3.5 mm, 4 pole jack. If your device is not compatible, you can use a 3 pole to 4 pole jack adapter.

: This icon is only available on the 8078s Premium DeskPhone.



### 7.21.2 Activate the ringing into the device

When you receive an incoming call, you can configure your desk phone to alert you of the incoming call directly via the connected device. In idle state, you can hear the ringing via the connected device (headset for example) in addition to the phone ringing. If you are in conversation, the phone alerts you of the incoming call by a signal via the connected device (the signal depends on the configuration of the system and can be one beep or three beeps for example).

-  Or  (long press) › [AudioHub](#)
- [Jack](#) › [EHS](#)
- [Jack ring](#): select this option to be alerted of an incoming call via the connected device.

### 7.21.3 Use a device compatible with Android mobile



If you connect a headset compatible with an Android device, you have to adjust the behavior of your phone to use the on-hook/off-hook button of the connected device:

-  Or  (long press) › [AudioHub](#)
- [Jack](#) › [EHS](#)
- [Android](#): select this option to use a headset compatible with Android.

Other buttons except on-hook/off-hook button of the compatible Android device are not supported by the phone.

### 7.21.4 Use a wireless DECT headset connected to the jack connector

Some DECT headsets optimize the battery by pausing the DECT radio when the phone is not in communication. In this case, the phone has to give the information to the headset via the jack connector. You have to configure the jack connector according to the following:

-  Or  (long press) › [AudioHub](#)
- [Jack](#) › [EHS](#)
- [ACOM jack only](#): select this option to use a wireless DECT headset.

## 7.22 Install a USB accessory (Headset, Handsfree, Loudspeaker)

- Connect the accessory to the USB connector.
- When you plug the accessory in the USB port, the USB accessory is automatically detected. If an another accessory is already connected with the same function (USB, jack or Bluetooth® if available), a popup asks you to select your preferred accessory to use for this function.

If you are using a Bluetooth® headset provided with a Bluetooth® USB dongle, you can connect the headset to the USB connector. Use and connectability depend on the vendor of the headset.

: This icon is only available on the 8078s Premium DeskPhone.

## 7.23 Install a RJ9 headset (8008G/8008 DeskPhone)



You can connect a corded headset to your phone using the RJ9 connector behind the phone. Your headset must be compatible with the connector or an adapter must be used. Some USB or jack headsets can be used with a RJ9 adapter. Consult the list of accessories for compatible headsets: List of accessories.





## 7.24 Manage connected devices

: This icon is only available on the 8078s Premium DeskPhone.



### 7.24.1 List of connected devices

-  Or  (long press) > [AudioHub](#)
- [Devices](#)
- The list of connected devices is displayed. You can find information about the connector:

-  : USB.
-  : Jack.
-  : Hands-free.
-  : Handset.



If two devices are connected to the desk phone and have the same function, two icons are displayed in the same line. The dark icon is the default device.

For example, in the following example, a USB headset and a jack headset are connected. The default headset is the one connected to the jack connector.



### 7.24.2 Default device

If you have connected the same type of accessory onto different connectors (for example, one headset to the jack connector, one headset to the USB connector and one Bluetooth® headset), the list of used connectors is display for each type of accessory. You can select your preferred accessory to be used as the default accessory.

-  Or  (long press) › *AudioHub*
- *Devices*
- The list of connected devices is displayed.
- Select the device with more than one connector icons.
- Select your preferred accessory
- 

### 7.25 Installing and using an ALE Bluetooth® wireless handset

This feature is only available with compatible Bluetooth® desk phone. Two Bluetooth® handsets are provided by ALE International.

Please consult the following chapter depending on the handset in your possession (grey or color buttons):

- ALE Wideband Bluetooth® Handset.
- ALE Bluetooth® Handset.

### 7.26 Installing a Bluetooth® Wireless Technology headset (pairing)



This feature is only available with compatible Bluetooth® desk phone. Otherwise the corresponding menu is not displayed or is inactive.

A multi-point Bluetooth® headset can be provided by ALE International.

This headset can be paired to your mobile phone and other communication devices at the same time. For example, you can use the headset paired to your mobile and when you enter your office the headset automatically matches to your office set too.

You can then answer a call using your Bluetooth® headset or the Bluetooth® Handset on the office set.

Before a Bluetooth® headset can be used, it must be correctly paired to the terminal. Before performing the pairing operation, the headset must be in detectable mode.

- Use one of the following:
  - 
  -  (long press) › *Bluetooth®*
- *Search devices*

›› Searching for Bluetooth® equipment. Wait for the detected equipment type and address to be displayed

- Select the relevant equipment.
- *Add*
- Enter the PIN code of the headset\*.
- *Confirm* ›› Acknowledgement message and display of the headset icon on the terminal screen.

\*Refer to the user documentation supplied with the headset.

: This icon is only available on the 8078s Premium DeskPhone.





## 7.27 Using a Bluetooth® Wireless Technology headset

This feature is only available with compatible Bluetooth® desk phone. Otherwise the corresponding menu is not displayed or is inactive.

Refer to the user documentation supplied with the headset.

## 7.28 Display all paired Bluetooth® devices

This feature is only available with compatible Bluetooth® desk phone. Otherwise the corresponding menu is not displayed or is inactive.



- Use one of the following:
  - 
  -  (long press) › *Bluetooth®*
- *Devices*

› Display of the different equipment paired.

: This icon is only available on the 8078s Premium DeskPhone.

## 7.29 Improve the Bluetooth® audio quality in a high Wi-Fi density environment



If a Wi-Fi network interferes the Bluetooth® signal, you can activate the following option to improve the Bluetooth® audio quality:

- Use one of the following:
  - 
  -  (long press) › *Bluetooth*
- *Noise cut: check this option.*

Note that the autonomy of the Bluetooth® device will decrease if the option is enabled.

## 7.30 Removing a Bluetooth® accessory (headset, handset, etc.)

This feature is only available with compatible Bluetooth® desk phone. Otherwise the corresponding menu is not displayed or is inactive.

- Use one of the following:
  - 
  -  (long press) › *Bluetooth®*
- *Devices*

›› Display of the different equipment paired.

- Select the equipment to be removed.
- *Remove*
- 

› Message acknowledging the equipment has been removed.

: This icon is only available on the 8078s Premium DeskPhone.

## 8 Contacting your administrator (Technical support)

If necessary you may need to contact your administrator.

Before contacting your administrator, make sure you have information such as your phone's codes and software version to hand.

### 8.1.1 Technical code / Date code

The codes are located under the backshell of the phone. This label is an example and does not represent the one placed on your phone.

<b>1</b>	Technical code.
<b>2</b>	Date code.



### 8.1.2 Software version

The software version can be viewed on the phone by following this path:

- Use one of the following:
  -  (long press) › *About* › *Software*
  - Reach the 'Menu' page › *Settings* › *Options* › *Version*

## 8.2 Hardware model

The hardware model can be viewed on the phone:

-  (long press) › *About* › *Hardware* (If available on your phone).

## 8.3 Phone auto test

The auto test of the phone is a quick hardware test of the sound, the display and the LEDs. It lets the user do the first tests directly from the desktop.

- The phone is switched on and connected.
- Reach the 'Menu' page.
- [Settings](#) › [Options](#) › [Phone test](#)
- Auto test has started.
-  To stop the auto test.

## 8.4 Access to administrator configuration

Your administrator can access to the phone configuration. Depending on the system configuration, an administrator password is requested to access this menu.

- Start your desk phone by connecting it to the network (and plugging in the power jack if you are using an external power adapter).
- When the desk phone displays the 'Step 2' during the boot, repeatedly press the '\*' and '#' keys in succession until a menu is displayed.
- This section allows the administrator to set or consult:
  - IP parameters: [IP Parameters](#) › [IP Status](#)
  - DHCP option: [IP Parameters](#) › [IP Config](#)
  - Phone memory: [IP Parameters](#) › [Memories](#)
  - Used network (wired or wireless): [Network](#)
  - Wired network configuration: [Network](#) › [Wired network](#)
  - Wireless network configuration: [Network](#) › [Wireless network](#)
  - VPN configuration: [VPN](#)
  - Security: [Security](#)
  - Software information (version, run mode): [Software infos](#)
  - Hardware information (MAC, CPU): [Hardware infos](#)
  - Beacon activation: [Hardware infos](#) › [Bluetooth info](#) › [Beacon: Enable Beacon](#)
  - Software update mode: [Software infos](#) › [Upgrade](#)
    - [Enable software upgrade](#): upgrade via network (system).
    - [Upgrade from USB now](#): use a USB drive to upgrade the software when you restart the desk phone.
  - Network default parameters (reset configuration): [Network](#) › [Set default](#)
  - Factory configuration: [Reset to Defaults](#)

## 9 ACD: Agent set/ Supervisor station

### 9.1 Agent set

A call center solution allows optimum distribution of calls to agents according to their availability and skills.

### 9.2 Open an agent session (LogOn) – Agent set

- Reach the 'Menu' page.
- *LogOn*
- Enter the identifier number.
- Enter your personal password.

#### 9.2.1 For a decision maker agent

- Use one of the following:
  - Enter the processing group number.
  - *List >>* Select the processing group from a list.

### 9.3 ACD application welcome screen – Agent set

Once the ACD session is open, the agent can access the ACD application dedicated functions.

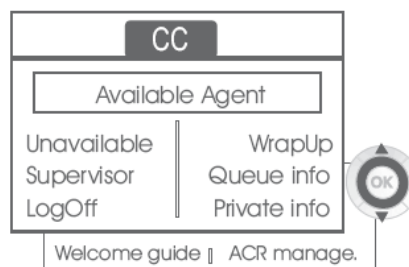

- *Unavailable*  
This function allows the agent to be 'logged out' from the ACD application. The 'logged out' function is activated - by default, on opening an agent session (system configuration), by the supervisor or by the agent himself. The agent changes this 'logged out' status by pressing the display key associated with this function.
- *Wrap Up*  
After each ACD call, the agent automatically assumes Wrap-up mode. During this mode, the agent does not receive any ACD calls and can carry out the tasks associated with a call. This mode can be terminated at any time by pressing the display key associated with the Wrap-Up function or by waiting for the end of the timer (system configuration).
- *Supervisor*  
When the agent is on a break, waiting for a call or in Wrap-up mode, he calls his supervisor directly by pressing this key.
- *Queue info*  
By pressing this key, the agent accesses information regarding the queue (number of calls waiting, average or maximum waiting time, number of free, busy or logged out agents).
- *Private info*  
Pressing this key informs the agent about the configuration of his set (forwarding status, presence of new messages, associated set, name and number of the set, etc.).

- *Welcome guide*  
This key allows the agent to configure the welcome messages, recording, activation/deactivation, loading or playback of a welcome message.  
Access to welcome message configuration involves entering the agent identifier number and a password.
- *ACR manage.*  
The agent can act on the distribution of the ACD calls by assigning or not assigning expertise areas. Expertise areas can be assigned or deleted one by one or globally.
- *Help*  
During a communication, the agent can send an assistance request to the supervisors.  
This request can be accepted by a supervisor or rejected if the supervisors are absent, not available or reject the request.

## 9.4 Close an agent session (LogOff)

- *LogOff*
- Enter your personal password.
- *Apply* >> The session is closed.

## 9.5 Supervisor station

The supervisor is an agent who has been assigned additional rights. In particular, he can assist the agents, supervise agent activity, intrude or listen-in discretely on a call.

A supervisor can also perform the agent function from the same set.

## 9.6 Open a supervisor session (LogOn)

- Reach the 'Menu' page.
- *LogOn*
- Enter the identifier number.
- Enter your personal password.

CC	
1300	
Entry	Queue info
LogOff	Private info
Welcome guide	ACR manage.

## 9.7 Processing group- Supervisor entry/withdrawal

- *Entry*
- Use one of the following:
  - Enter the processing group number.
  - *List* >> Select the processing group from a list.

## 9.8 Supervision or acceptance of an assistance request

The supervisor has access to the supervision functions either by accepting an assistance request from an agent or by pressing the 'Help ' function key in the 'Perso ' page.

ACD Listening	
Agent number :	
Listen	Intrusion
Restrictive	Permanent
Cancel	

- **Listen**  
By pressing this key, the supervisor starts a discrete listen-in procedure. The supervisor can then listen in on the conversation between an agent and his caller, but cannot participate in the conversation.
- **Intrusion**  
This key allows the supervisor to intrude in a communication. This intrusion is signalled to the agent and his caller by an audible beep and the supervisor can cut-in on the conversation at any time. If the agent on-hooks or if the supervisor presses the 'Help ' key, only the supervisor and the caller will be in communication.
- **Restrictive**  
The agent is in communication with a caller. This function allows the supervisor to talk just with the agent without the caller being informed of this intrusion (restrictive).
- **Permanent**  
The supervisor can view on his display the dynamic states (out of service, ACD calls, private calls, Wrap-up, pause, etc.) and static states (withdrawn, available, Log-Off, etc.) of an agent in real-time.
- **Cancel**  
Pressing this key results in the rejection of an agent assistance request.

## 9.9 Close a supervisor session

- **LogOff**
- Enter your personal password.
- **Apply >>** The session is closed.

# 10 Use the telephone in SIP survivability ('safe' mode)

For more information, contact your installer or administrator.



Pre-programmed function keys are disabled in SIP mode.

**123<>abc**: If your set is not provided with a magnetic keyboard, use the alpha-numeric keyboard to enter letters. Use the alpha-numeric keyboard key to switch between the numeric and alphabetic keyboard. When in alphabetic mode, the LED corresponding to the key remains lit up.

## 10.1 Making a call

### 10.1.1 Take the line

Use one of the following:

- Unhook the handset › Enter the destination number.
-  Hands-free › Dial the destination number.
-  Line key › Dial the destination number.



›› You hear a tone.

### 10.1.2 Call by dialing internal number of your contact

Use one of the following:

- Dial directly the number for your call.
- Take the line › Dial the destination number › *Call*

### 10.1.3 Call using your contact's URI



- Take the line.
- *Dial by URI*
- 
- Enter your contact's URI.
-  / *Call*

In SIP mode, each telephone is identified by a character string called the URI. Within your company, the URI of your contact is usually the contact's telephone number.

## 10.2 Make a call using the personal phone book

- Use one of the following:
  - *Directory*
  - Take the line › *From directory*
- Select your contact from the list.
- *Call*

## 10.3 Redialing the last number dialed

-  /  Redial key (short press) >> Last number redial.

## 10.4 Receiving a call

### 10.4.1 Stop the ringer

Use one of the following:

-  Press this key once.
- *Silence*



### 10.4.2 Reject the call displayed

Use one of the following:



-  Press this key twice.
- *Reject call*

### 10.4.3 Answer the call

Use one of the following:

- Unhook the handset.
-  Hands-free.
- *Take call*
-  Select the 'incoming call' icon.
-  Line key.



## 10.5 Making a second call during a conversation

- During a conversation.
- Use one of the following:
  - *New call* >> The first call is on hold.
  -  Free line key.
- Use one of the following:
  - Number of second contact.
  - *Dial by URI* >> Call using your contact's URI.
  - *From directory* >> Call from your personal directory.
  -  /  Redialing the last number dialed.

In SIP mode, each telephone is identified by a character string called the URI. Within your company, the URI of your contact is usually the contact's telephone number.





### 10.5.1 To cancel your second call and recover the first



- You are in conversation with the second contact and the first one is on hold.
- Use one of the following:
  - *Enquiry off*
  -  Hang up
- Use one of the following:
  -  Line key with light flashing
  - *Retrieve*

» You are on the line with your first contact

### 10.6 Answering a second call during a conversation

- During a conversation, another person is trying to call you » Name or no. of the caller displayed for 3 seconds.
- Use one of the following methods to answer the displayed call.
  -  Line key for which icon is flashing.
  -  Line key with light flashing.
  - *Take call*
- The first call is on hold.

To return to your first contact and end the conversation in progress

- Use one of the following:
  - *Enquiry off*
  -  Hang up.
- Use one of the following:
  -  Line key with light flashing.
  - *Retrieve*



» You are on the line with your first contact

### 10.7 Placing a call on hold (hold)

During a conversation, you wish to place the call on hold and recover it later, on the same telephone.



- During a conversation.
- *Put on hold* » Your call is placed on hold .

Recover the call on hold.

- Use one of the following:
  -  Line key with light flashing.
  - *Retrieve*
  -  Line key for which icon is flashing.

## 10.8 Switching between calls (Broker call)



During a conversation, a second call is on hold.

- Select the contact on hold (/ ) >> You are in conversation with the second contact and the first one is on hold.

## 10.9 Transferring a call

- You are in communication with a first caller.
  - Calling a second person during a conversation >>The first call is on hold.
  - *Transfer to* >> The two callers are connected.
- You are in communication with two callers.
  - *Transfer* >> The two callers are connected.
- You are in communication with a first caller. A second caller is on hold. You want to transfer the ongoing call to a 3rd caller.
  - *Transfer to 3rd*
  - Call the recipient of the transfer.
  - *Transfer to* >> The two callers are connected.

Recover the call on hold.

- Use one of the following:
  -  Line key with light flashing.
  - *Retrieve*
  -  Line key for which icon is flashing.

## 10.10 Three-way conference with internal and/or external contacts (conference)

- During a conversation, a second call is on hold.
- *Conference* >> You are in conference mode.

### 10.10.1 Hang up on all participants (If conference is active)





- Use one of the following:
  -  Hang up.
  - *End of conference*

### 10.10.2 After the conference, to leave your two contacts talking together

- *Transfer*
-  Hang up.

## 10.11 Mute, so that your contact cannot hear you

You can hear your contact but he/she cannot hear you:

- During a conversation.
-  Disable microphone >> The key lights up .
-  Resume the conversation >> The key is no longer lit .

## 10.12 Adjust audio volume

To adjust the volume level of the loudspeaker, handset or headset during a call:

-   Adjust audio volume.

## 10.13 Forwarding calls to another number (immediate forward)

The number can be your home, mobile, voice mailbox or an internal extension (operator, etc.).

- *Forward* >> Display the forwarding status of your set.
- *Immediate fwd*
- Call the recipient of the forwarding.
- *Save* >> Validate the forwarding.
- 

You can make calls, but only the destination number can call you.

### 10.13.1 Modify the forwarding

- *Forward* >> Display the forwarding status of your set.
- *Immediate fwd*
- Call the recipient of the forwarding.
- *Save* >> Validate the forwarding.
- 





### 10.13.2 Cancel the forwarding

- *Forward* >> Display the forwarding status of your set.
- *Deactivate*
- 







## 10.14 Adjusting the audio functions

- Reach the 'Menu' page.
- *Settings* > *Phone* > *Ringing*





### 10.14.1 Choose the tune

- *Melody*
- Select the melody of your choice (16 tunes).
- 
-  >> End.
-  /  >> To adjust other audio features.





### 10.14.2 Adjusting the ringer volume

- *Level*
-   Select the volume you want (12 levels).
- 
-  >> End.
-  /  >> To adjust other audio features.



### 10.14.3 Activate/deactivate silent mode / Activate/deactivate meeting mode (progressive ringing)

- *More options*
  - *Normal ringing*
  - *Silent mode*
- *Progressive ringing*
- 
-  >> End.
-  /  >> To adjust other audio features

### 10.14.4 Activate/deactivate discreet ring mode

- *Beep*
- *One beep before ringing*
- *Three beeps before ringing*
- *Ring without beep*
- 
-  End.
-  /  To adjust other audio features.

### 10.14.5 Adjust ringer volume while a call arrives

- Your telephone rings.
-   Adjusting the ringer volume.

## 10.15 Selecting language

- Reach the 'Menu' page.
- *Settings* > *Phone* > *Language*
- Select the language of your choice.
- 

## 10.16 Sending DTMF signals

During a conversation you sometimes have to send DTMF signals, such as with a voice server, an automated attendant or a remotely consulted answering machine.

By default during a communication, your telephone in SIP mode is configured to send codes in voice frequency: enter these codes directly using the keys on your telephone.

For more information regarding this configuration, contact the person in charge of your installation.

# 11 Accessories

The ALE-supported accessories are intended to work smoothly on most/all of our clients (hardphones, softphones). The list of accessories presented in this document is not contractually binding and may be modified without prior warning.

## 11.1 List of accessories

### 11.1.1 Jack 3.5 mm 4-pole corded headset (ALE catalog)

- Corded Binaural Wideband Headset 3GV28048AD (Plantronics HW520N)\*. Quick Disconnect (QD) - Cables Jack 3,5 mm, 4-pole and 3-pole
- Corded Monaural Wideband Headset 3GV28047AD (Plantronics HW510N)\*. Quick Disconnect (QD) - Cables Jack 3,5 mm, 4-pole and 3-pole



\*Compatible with 8008/8008G DeskPhone with RJ9 adapter: QD RJ9 adapter 3GV28177AA.

\*\*Compatible with 8008/8008G DeskPhone with RJ9 adapter (Sennheiser CSTD 01).

It is recommended to update the device with the last version of the firmware and configure it in 'default' mode.

### 11.1.2 USB headset

- Corded Monaural USB A 3MK08011AA (Alcatel-Lucent Enterprise AH 21 U).
- Corded Binaural USB A 3MK08012AA (Alcatel-Lucent Enterprise AH 22 U).
- Corded Binaural USB A 3MK08014AA (Alcatel-Lucent Enterprise AH 22 M).



### 11.1.3 Bluetooth® headset

Your phone delivers wideband audio on compatible Bluetooth® headset (see chapter below: Other headsets).

### 11.1.4 Adapter

- QD RJ9 adapter 3GV28177AA (Box of 10 - Plantronics).
- 80XX JACK 4-3 POLE CABLE (Box of 10) 3MG08018AA.
- 80x8S SATA-RJ11 CABLE (Box of 10) 3MG08019AA.
- USB C to USB-A CABLE (Box of 10) 3MG08020AA.

### 11.1.5 EHS interface

- USB external ringing interface module 3GV28184AA (USB Interface module 2 relays).
- External ringing interface module 3GV28050AA (MWS) - phased-out.

### 11.1.6 USB Dongle

- Dongle USB OmniAccess Stellar BLE (Box of 10) OAL\_PT\_USB\_10.

### 11.1.7 Other headsets

Compatible headsets are validated by the Developer and Solution Partner Program (DSPP) (See chapter: 11.6 Developer and Solution Partner Program (DSPP)).

## 11.2 USB external ringing interface module (USB Interface module 2 relays 3GV28184AA)

	8078s BT	8078s	8068s BT	8068s	8058s	8028s	8018	8008 8008G
The accessory is supported by the following sets	●	●	●	●	●	●	●	

The USB external ringing interface module allows driving an external system (like a ring or a lamp), following the ring tone cadence or the communication state of the phone connected on the telephone line. No system configuration is requested to install the module.

USB Interface module 2 relays lets to connect directly one or 2 external ringings on the USB connector of your desk phone:

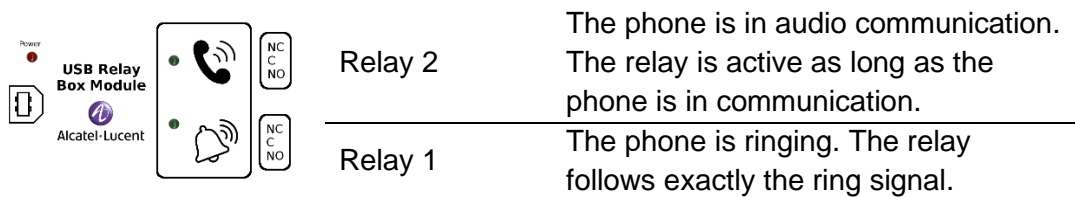

### List of supplies

- USB external ringing interface module.
- 1 USB cable 1,5 m (4,9 feet) USB type A - USB type B.

### 11.2.1 Installation

**WARNING:** The module must be closed before use. No settings require the module to be open.

In idle state:

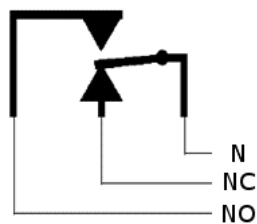

Ringing or during communication:

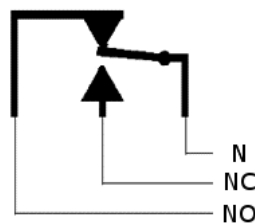

N: Common.  
NC: Active signal.  
NO: Non-active signal.

Typical usage diagram:

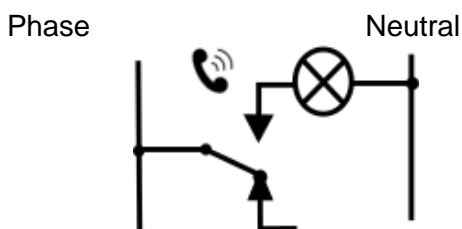

The lamp lights up when the phone is in communication.

The breaking capacity is 12V/24V DC 15A or 120V/220V AC at 10A.

## 11.2.2 Connect the device





- Plug the provided cord USB type B on the USB connector of the module.
- Plug the provided cord USB type A on the USB connector of the desk phone. See description of the connectors of your phone.

### 11.3 External ringing interface module (MWS 3GV28050AA) - phased-out

	8078s BT	8078s	8068s BT	8068s	8058s	8028s	8018	8008 8008G
The accessory is supported by the following sets	●	●	●	●	●	●		

You have to use a RJ11 to SATA adapter to connect your desk phone to this device. The RJ11 to SATA adaptor is sold separately (3MG08019AA).

The external ringing interface module allows driving an external system (like a ring or a lamp), following the ring tone cadence of the phone set connected on the telephone line. A switch on the electronic board allows selecting between 2 operation modes.

-  Follows the cadence: the relay follows exactly the ring signal.
-  Hold mode: the relay is held for 0,7 s after the ring signal is gone. It erases some of the ring pulses.

#### 11.3.1 List of supplies

- 1 external ringing interface module.
- 3 circuits plug to screw.
- 1 RJ11/RJ11 3 meters (10 feet) cable.
- 1 DC Japan/DC Japan 3 meters (10 feet) power cable.

A power supply may be required to power the module when used with IP phone powered remotely (Power Over Ethernet).

Use only the following power supply (sold separately): 3MG27006xx

#### 11.3.2 Installation



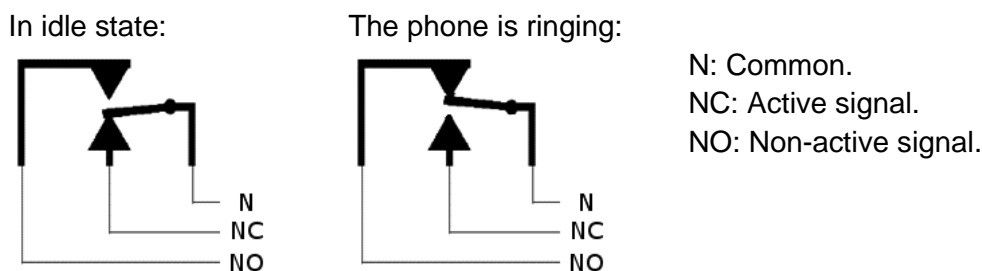

**WARNING:** The module must be closed before use. No settings require the module to be open.





### 11.3.3 Connect the device



<b>Phone set connected over IP and to an external power supply</b>		
<b>1</b>	Connected to the DC power jack of the desk phone by using DC Japan cable.	
<b>2</b>	Connected to the power supply of the device.	
<b>3</b>	Connected to the SATA connector of the desk phone, by using the RJ11 cable with an adaptor RJ11 to SATA. The RJ11 to SATA adaptor is sold separately.	 SATA
<b>Phone set connected over IP and PoE</b>		
<b>1</b>	Connected to the DC power jack of the desk phone by using DC Japan cable.	
<b>2</b>	Connected to the power supply of the device.	
<b>3</b>	Connected to the SATA connector of the desk phone, by using the RJ11 cable with an adaptor RJ11 to SATA. The RJ11 to SATA adaptor is sold separately.	 SATA

## 11.4 Wall mounting kit

### 11.4.1 8068s, 8058s, 8028s Premium DeskPhone

1

1. Rotate the metal foot to flat.
2. Remove the rubber cover on phone back shell each side.

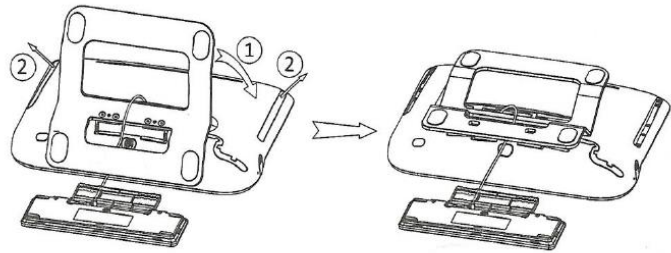

2

1. Drill two holes on the wall (separation=90mm, diameter=6mm).
2. Insert the fastener into the holes on wall (P/N: 1AD007550003).
3. Fix the support with both screws and adjust (P/N: 1AD007460003 – Diameter= 3,5 mm, Length= 25 mm). The support is used as a reference and must be removeable.

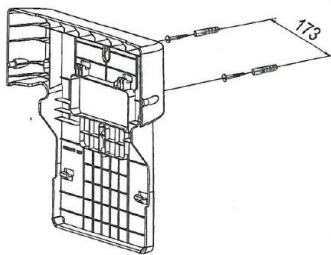

3

1. Put the support on the back side of the phone.
2. Slide it to top side and make sure the 4 hooks hold the metal foot.
3. Attach the magnetic alphabetic keyboard to the metal foot.
4. Push on the two corners of mini-keyboard to fix it in the support.

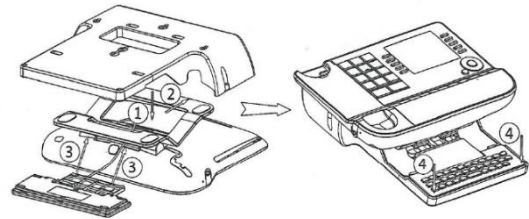

4

1. Fix the support with the phone by 2 screws (P/N: 1AD100020003 – Diameter= 2,1 mm, Length= 14,5 mm).
2. Connect cables through the hole on support left side or right side.

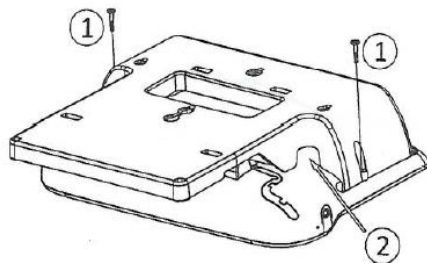

To connect ethernet, use RJ45 cable (P/N: 1AB045210162).  
To connect the power, use extension cable (P/N: 1AB203010001).

5

1. Hang the assembled phone with support on the wall.

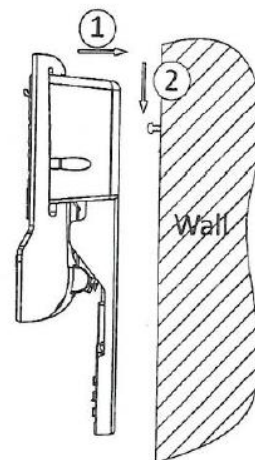

11.4.2 8018 DeskPhone

1

1. Drill two holes on the wall (separation=90mm, diameter=6mm).
2. Insert the fastener into the holes on wall (P/N: 1AD007550003).
3. Fix the support with both screws and adjust (P/N: 1AD007460003 – Diameter= 3,5 mm, Length= 25 mm). The support is used as a reference and must be removable.

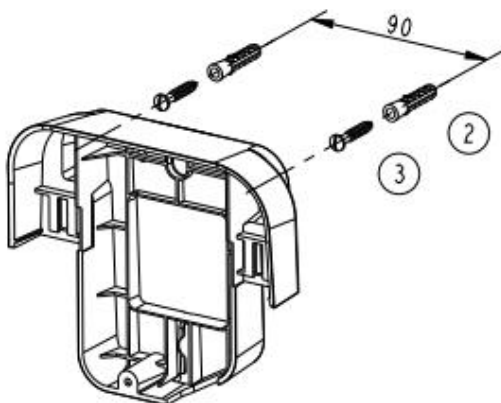

2

1. Put the support on the back side of the phone.
2. Slide it from top side and make sure the 2 snaps are engaged on the shell.

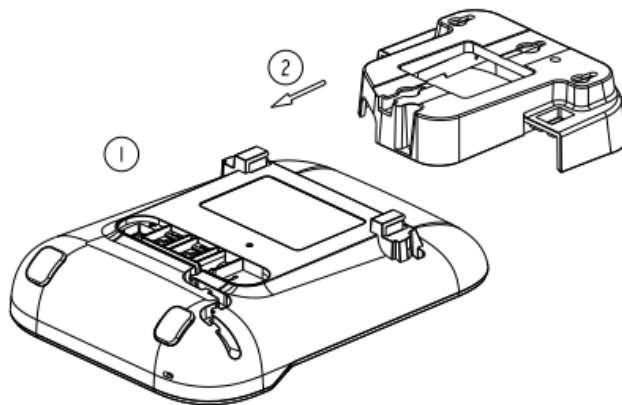

3

1. Fix the support with the phone by 1 screw (P/N: 1AD204430001 – Diameter= 2,5 mm, Length= 8 mm).
2. Connect cables through the hole on support bottom side.

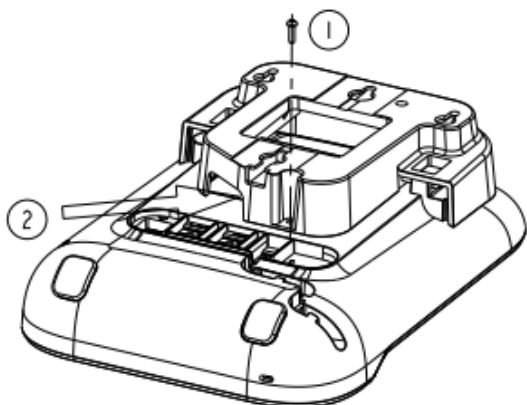

4

1. Hang the assembled phone with support on the wall (P/N: 1AB045210162).

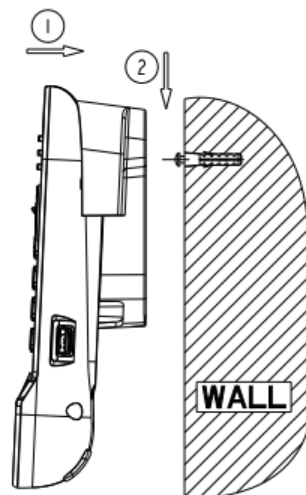

5

To make sure that the handset is properly hung up when the phone is attached to the wall, place the clip in a wall-mount configuration (arrows up), as shown in the following illustration: remove the hook from its location, turn it over if necessary and replace it in its location.

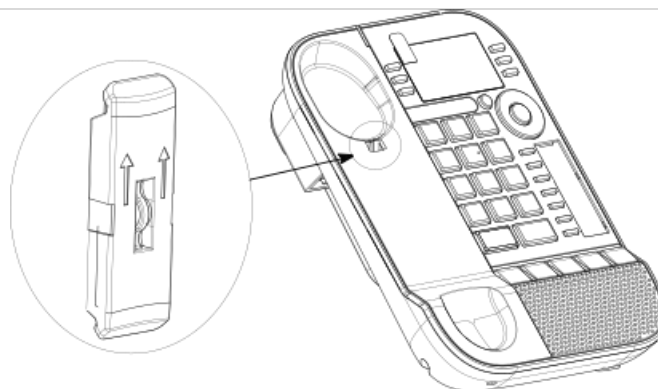

## 11.4.3 8008/8008G DeskPhone

## Installation of the wall mount kit

1

Fix the wall mount kit on the wall by using the 4 provided screws and nylon anchors. You can use the support as a reference to mark position. Remove it before drilling holes.

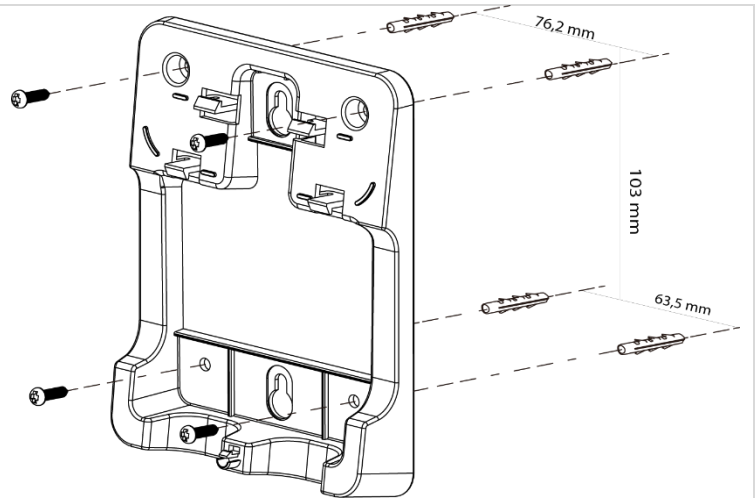

2

Assemble the phone with the wall mount kit by using the 5 hooks of the support.

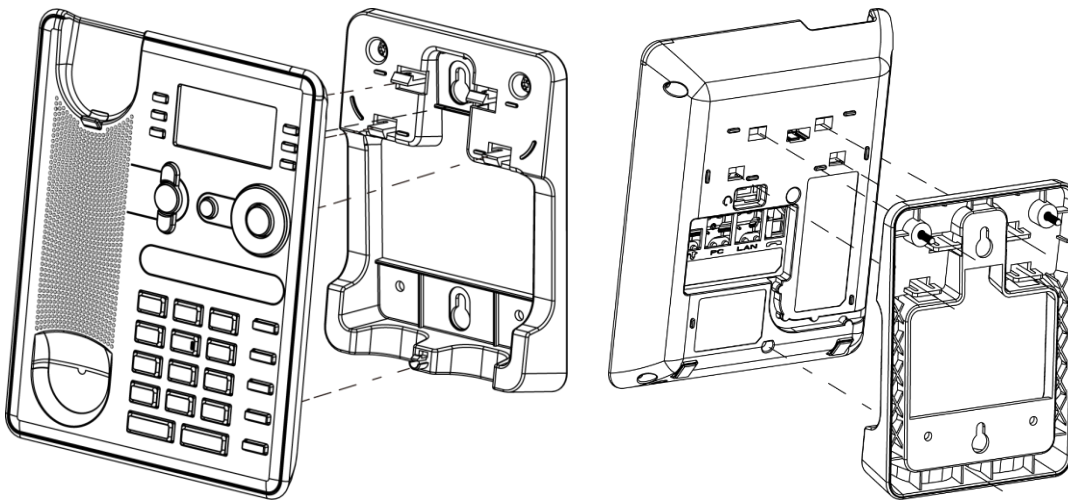

## Pull out the phone from the support

1. Maintain the support with one hand by using the two holes on the bottom of the wall mount kit.
2. With the other hand, pull out the phone from the support as shown in the image.

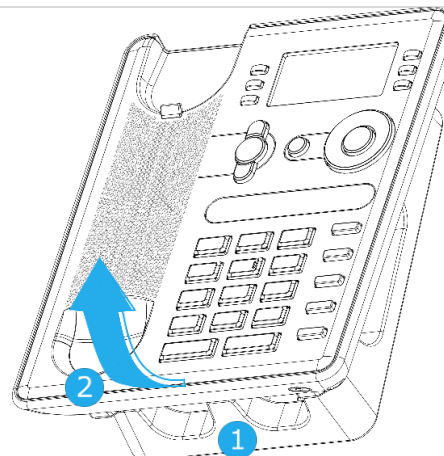

## 11.5 Connect a 3 pole jack headset

Your phone is equipped with a 3.5 mm, 4 pole jack. If your headset is not compatible (3 pole jack), you have to use adapters. Contact the manufacturer of your headset to find the appropriate adapter.

Use the following kit which contains a 3 pole to 4 pole jack adapter and a RJ11 to SATA adapter:

- 80XX JACK 4-3 POLE CABLE (Box of 10) 3MG08018AA
- 80x8S SATA-RJ11 CABLE (Box of 10) 3MG08019AA

1	A 3 pole to 4 pole jack adapter to connect the jack of the headset to the DeskPhone to manage audio.
2	RJ11 to SATA adapter to connect the RJ11 connector of the headset to the SATA connector to the DeskPhone to manage ringing. Some manufacturers provide the Sata connector. In this case, the adapter is not useful.
3	EHS adapter (depends on accessory manufacturer).

For example:

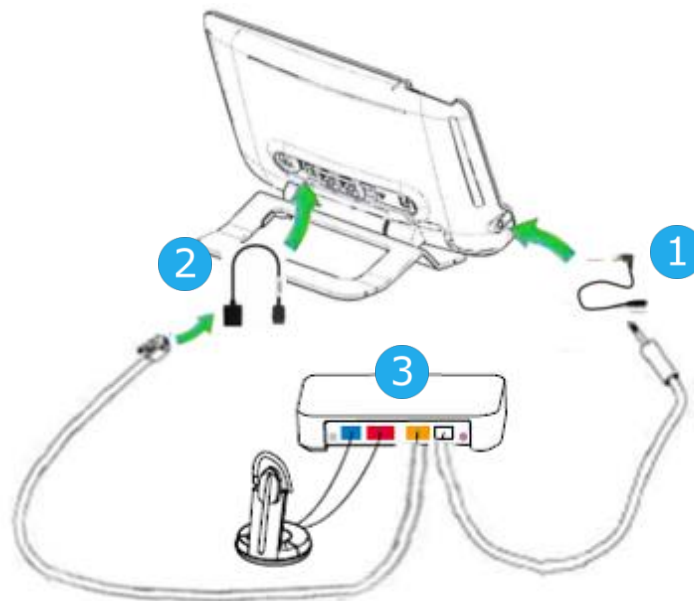

## 11.6 Developer and Solution Partner Program (DSPP)

The mission of the DSPP is to support a broad ecosystem of developers and partners throughout the desk phone lifecycle. In this context, certification tests are performed between partner applications or devices and Alcatel-Lucent Enterprise's platforms. It certifies proper inter-working with partner applications or devices.

Consult the list of available headsets: "List of certified 3rd parties Headsets for Hard phones and Soft phones".

Results of certification tests for headsets can be consulted by following links below.

- IWR-0121: Sennheiser Headsets / Desk phones  
<https://www.al-enterprise.com/-/media/assets/internet/documents/sennheiser-headsets-terminals-iwr-0121-ed10-en.pdf>
- IWR-0018: Jabra Headsets for hardphones  
<https://www.al-enterprise.com/-/media/assets/internet/documents/iwr-0018-ed03-gn-jabra-headsets-amplifiers-omnipcxplatformsterminals.pdf>
- IWR-0164: Plantronics-Headsets-Amplifiers  
<https://www.al-enterprise.com/-/media/assets/internet/documents/plantronics-headsets-amplifiers-iwr-0164-ed04.pdf>

We recommend connecting the headset via the desk phone USB connector and not using the provided hub if delivered with the headset.

# 12 Technical specifications

	<b>8078s BT</b>	<b>8078s</b>	<b>8068s BT</b>	<b>8068s</b>	<b>8058s</b>
Width	252 mm (9,92 in)	252 mm (9,92 in)	252 mm (9,92 in)	252 mm (9,92 in)	252 mm (9,92 in)
Depth on a table	200 mm (7,87 in)	200 mm (7,87 in)	200 mm (7,87 in)	200 mm (7,87 in)	200 mm (7,87 in)
Height	204 mm (8,03 in)	204 mm (8,03 in)	204 mm (8,03 in)	204 mm (8,03 in)	204 mm (8,03 in)
Weight	1450 g	1450 g	1350 g	1350 g	1350 g
Adjustable foot stand range	25° - 60°	25° - 60°	25° - 60°	25° - 60°	25° - 60°
Color	Moon grey	Moon grey	Moon grey	Moon grey	Moon grey
Display	5 inch capacitive touch color, 480 x 800 pixels, effective display area size 108.00 x 64.80 mm	5 inch capacitive touch color, 480 x 800 pixels, effective display area size 108.00 x 64.80 mm	3.5 inch color, 240 x 320 pixels, effective display area size 70.08 x 52.56 mm	3.5 inch color, 240 x 320 pixels, effective display area size 70.08 x 52.56 mm	3.5 inch color, 240 x 320 pixels, effective display area size 70.08 x 52.56 mm
Power over Ethernet (IEEE 802.3af)	Class 2	Class 2	Class 2	Class 2	Class 2
Power consumption (PoE) Idle – Active(w/o Add-on, w/o USB)	2.1 W – 3.5 W	1.9 W – 3.2 W	2 W - 3.1W	1.8 W - 2.8 W	1.6 W – 2.2 W
Operating conditions	-5°C - +45°C (23°F - 113°F)	-5°C - +45°C (23°F - 113°F)	-5°C - +45°C (23°F - 113°F)	-5°C - +45°C (23°F - 113°F)	-5°C - +45°C (23°F - 113°F)
USB-A USB-C	USB 1.1 USB 2.0	USB 1.1 USB 2.0	USB 1.1 USB 2.0	USB 1.1 USB 2.0	USB 1.1 USB 2.0

	<b>8028s</b>	<b>8018</b>	<b>8008/8008G</b>
Width	252 mm (9,92 in)	164 mm (6.46 in)	150 mm (5,91 in)
Depth on a table	200 mm (7,87 in)	200 mm (7.87 in)	34,8 mm (1,37 in)
Height	204 mm (8,03 in)	170 mm (6.69 in)	195 mm (7,68 in)
Weight	1350 g (2.98 lbs)	675 g (1.48 lbs)	508 g (1,12 lbs)
Adjustable foot stand range	25° - 60°	45°	45°
Color	Moon grey	Moon grey	Moon grey
Display	2.8 inch, 64 x 128 pixels black & white, white backlight, effective display area size 64 x 32 mm	2.4 inches 128 x 64 pixels graphic black/white LCD display, effective display area size 54.8 x 28.5 mm (2.15 x 1.12 in)	2.4 inches 128 x 64 pixels graphic black/white LCD display, effective display area size 52 x 26 mm (2.05 x 1.02 in)
Power over Ethernet (IEEE 802.3af)	Class 1	Class 1	Class 1
Power consumption (PoE) Idle – Active(w/o Add-on, w/o USB)	1.5 W – 2 W		Power supply: Optional accessory
Operating conditions	-5°C - +45°C (23°F - 113°F)	-5°C - +45°C (23°F - 113°F)	-5°C - +45°C (23°F - 113°F)
USB-A	USB 1.1	USB 2.0	-
USB-C	USB 2.0	-	-



	<b>External ringing interface module (MWS 3GV28050AA)</b>	<b>USB external ringing interface module (3GV28184AA)</b>
Maximum distance between the phone set and the device	3 m (10 feet)	1,5 m (5 feet)
Width	124 mm (1,2 in)	100 mm (3,9 in)
Depth on a table	130 mm (5 in)	62 mm (2,4 in)
Height	30 mm (1,2 in)	26 mm (1 in)
Weight	170 g (0,37 lbs)	
Adjustable foot stand range		
Color	Black and silver	
Display		
Power consumption	500 mW	
Power consumption	2A 220 Vdc 250 Vac	15A 12/24Vdc 10A 120/220Vac
Battery		
UL/CSA Ratings	<ul style="list-style-type: none"> <li>• 30 Vdc / 2 A</li> <li>• 220 Vdc / 0.27 A</li> <li>• 120 Vdc / 0.5 A</li> <li>• 250 Vac / 0.25 A</li> </ul>	
Operating conditions		

# 13 Ordering information

This list is not exhaustive and may change at any moment.

8008 DeskPhone	3MG08010AA
8008G DeskPhone	3MG08021AA
8008 Wall mounting kit	3MG08013AA
8008 Power adaptor	3MG08011AA
QD RJ9 adapter	3GV28177AA
8018 DeskPhone	3MG27201AB
8018 Wall mounting kit	3MG27210AA
8018 Customizable clip (x10)	3MG27211AA
8018/8019S paper label + cover kit (x10)	3MG27222AA
8018/8019s Paper label (x64)	3MG27215AB
8018 Plastic foot (x10)	3MG27216AA
8028s Premium Deskphone	3MG27202xx
8058s Premium Deskphone	3MG27203xx
8068s Premium Deskphone	3MG27204xx
8078s Premium Deskphone	3MG27205xx
8068s Premium Deskphone BT	3MG27206xx
8078s Premium Deskphone BT	3MG27207xx
8028/8029 paper labels (x50)	3MG27114AA
Premium Add-on 10 keys module	3MG27105AC
Premium Add on 10 key modules paper labels (x64)	3MG27115AA
Premium Smart displays 14 keys module with clip	3MG27107AC
Premium Add-on 40 keys module with clip	3MG27106AC
Premium Add-on 40 keys module paper labels (x50)	3MG27116AA
80XX JACK 4-3 POLE CABLE (x10)	3MG08018AA
80x8S SATA-RJ11 CABLE (x10)	3MG08019AA
USB C to USB-A cable (Box of 10)	3MG08020AA
Super Wide Band Comfort Handset	3MG27220AA
Wide Band Comfort Handset	3MG27032AA
Wide Band Bluetooth Handset	3MG27209AA
8008 Standard Handset	3MG08012AA
Monaural AH 21 U Premium USB Headset	3MK08011AA
Binaural AH 22 U Premium USB Headset	3MK08012AA
Binaural AH 22 M Premium USB Headset	3MK08014AA
Binaural Wideband Headset (Plantronics HW520N)	3GV28048AD
Monaural Wideband Headset (Plantronics HW510N)	3GV28047AD
Magnetic Alphabetic Keyboard	3MG27208xx
Premium Wall Mounting Kit	3MG27110AA
AC/DC Power Adapter (100–240 V AC/48 V DC)	3MG27006xx
Dongle USB OmniAccess Stellar BLE (Box of 10)	OAL_PT_USB_10
External ringing interface module without PSU	3GV28050AA
USB external ringing interface module	3GV28184AA

# 14 Guarantee and clauses

Current Safety and Regulatory Statements relate to the 8008, 8008G, 8018 DeskPhone and 8028s, 8058s, 8268s, 8078s Premium DeskPhone sets only, and do not apply to accessories.

## 14.1 Safety Instructions

- Changes or modifications to the equipment not expressly approved by the party responsible for compliance could void the user's authority to operate the equipment.
- Magnets could affect the functioning of pacemakers and implanted heart defibrillators. Keep a safe distance between your pacemaker or implant defibrillator and the handset which includes magnetic elements: 4 centimeters (1,6 inches) at least.
- It is recommended to follow the standard acceptance procedures before using this equipment in human safety critical areas (hospitals...).
- The handset includes magnetic elements that may attract sharp metallic objects. To prevent injury, before each use ensure sharp metallic objects are not stuck to the earpiece and microphone.
- Avoid using phones (other than cordless type) during an electrical storm. There may be a remote risk of electric shock from lightning.
- Do not use this device in environments where there is a danger of explosion.
- Do not plug this phone into an Integrated Services Digital Network (ISDN) connection or into a regular Public Switched Telephone Network (PSTN) connection. This can result in severe damage to the phone.
- Never allow your telephone to come into contact with water.
- To clean your telephone, use a soft damp cloth. Never use solvents (trichlorethylene, acetone, etc.) which may damage the plastic parts of your telephone. Do not use aerosol cleaners.
- 8018 DeskPhone - 80x8 / 80x8s Premium DeskPhone - 8088 Smart DeskPhone - 8018 / 80x8s Cloud Edition DeskPhone: this product is intended to be supplied, either via the Ethernet (LAN) port, or via the DC-in by a Certified Direct Plug-In Power Unit approved as 'LPS' (Limited Power Source) against CSA/UL/IEC 60950-1 or CSA/UL/IEC 62368-1 and rated 48V dc, minimum 0.27A. allowed power supply is: WA-13B48R – Asian Power Devices Inc.
- 8008 DeskPhone - 8008 Cloud Edition DeskPhone: this product is intended to be supplied, either via the Ethernet (LAN) port (Class 1 PoE according to IEEE802.3), or via the DC-in by a Certified Direct Plug-In Power Unit approved as 'LPS' (Limited Power Source) against CSA/UL/IEC 60950-1 or CSA/UL/IEC 62368-1 and rated 5V dc, minimum 1A. allowed power supply is: KSAS0050500100D5D – KUANTECH.
- The power supply shall be connected to an easily accessible socket outlet .
- A Bluetooth® Handset with integrated battery is available with certain Product variants. The battery must be charged during 6 hours before initial use and must be replaced correctly to prevent danger of explosion. Use only the recommended battery. Contact your Business Partner if you need a spare battery.
- To limit the risk of interference, people with pacemakers must keep the wireless telephone away from their equipment (minimum distance of 15 cm/6 inches).
- Some Premium DeskPhones and Smart DeskPhones also offer a Bluetooth® radio interface for Bluetooth® handsets or other Bluetooth® devices frequency range 2402-2480 MHz, radiated power 5 mW.
- If you are connected to a POE connection do not use an external Power Supply.
- The PoE (Power over Ethernet) devices that supply or receive power and their connected cables must all be completely indoors.
- 8078s Premium DeskPhone - 8088 Smart DeskPhone: the cover of the phone screen is made of glass. This glass could break if the phone is dropped or it receives a significant blow. If the glass chips or cracks, stop using the phone and do not touch the broken glass as this could cause injury to you. Glass cracked due to misuse or abuse is not covered under the warranty.

## 14.2 Regulatory Statements

### EUROPE

This equipment complies with the essential requirements of following directives: 2014/53/EU (RED), 2014/30/EU (EMC), 2014/35/EU (LVD), 2009/125/EC (ErP), 2011/65/EU (RoHS).

Declaration of Conformity may be obtained from:

ALE International 32 avenue Kléber – 92700 Colombes, France

ebg\_global\_supportcenter@al-enterprise.com

### USA and Canada

Phones with Bluetooth® comply with Industry Canada's license-exempt RSSs. operation is subject to the following two conditions: (1) this device may not cause harmful interference, and (2) this device must accept any interference received, including interference that may cause undesired operation. this equipment has been tested and found to comply with the limits for a class B digital device, pursuant to Part 15 of the FCC Rules. These limits are designed to provide reasonable protection against harmful interference in a residential installation. This equipment generates, uses and can radiate radio frequency energy and, if not installed and used in accordance with the instructions, may cause harmful interference to radio communications. However, there is no guarantee that interference will not occur in a particular installation. If this equipment does cause harmful interference to radio or television reception, which can be determined by turning the equipment off and on, the user is encouraged to try correcting the interference by consulting the dealer.

### Exposure to Radio Frequency Signals

This equipment complies with radiation exposure limits set by FCC/IC and the Council of European Union for an uncontrolled environment. This equipment has very low levels of RF energy and is deemed to be compliant without testing of the specific absorption rate (SAR).

### User Instructions

Use this product in temperatures between -5°C to +45°C (23°F to 113°F).

This product is intended for use in an indoor environment only. This apparatus is Hearing Aid Compatible (HAC).

### Acoustic shock protection

Maximum sound pressure level for handset is compliant with European, US and Australian standards.

### Directive 2003/10/EC specifying the risks inherent in noise at work

The ring contributes towards overall daily noise - at its maximum setting, the level is 105 dBA at 60 cm from terminal. To reduce the level, the following is recommended:- reduce the setting (9 levels of 5 dB) - program a progressive ring.

### Privacy

Privacy of communications may not be ensured when using the Bluetooth® handset or any additional Bluetooth® device.



### Disposal

The equipment must be returned to a collection point for electronic equipment waste disposal. Defective batteries must be returned to a collection point for chemical waste disposal.

### Related Documentation

Other languages for these Safety and Regulatory Instructions and User Documentation are available at the following Web site:

<https://www.al-enterprise.com/en/products>.

www.al-enterprise.com The Alcatel-Lucent name and logo are trademarks of Nokia used under license by ALE. To view other trademarks used by affiliated companies of ALE Holding, visit:

[www.al-enterprise.com/en/legal/trademarks-copyright](https://www.al-enterprise.com/en/legal/trademarks-copyright). All other trademarks are the property of their respective owners. The information presented is subject to change without notice. Neither ALE Holding nor any of its affiliates assumes any responsibility for inaccuracies contained herein.

© Copyright 2021 ALE International, ALE USA Inc. All rights reserved in all countries.

# OpenTouch® Suite for MLE



	Silent mode.
	Telephone locked.
	Headset connected/Handsfree connected
	Appointment programmed.
	Encrypted signal icon.
	Wi-Fi.
	Incoming call icon.
	Call in progress icon.
	Call holding icon.
	Your contact ended the conversation.
	Encrypted call in progress.
	Audiohub is activated and a computer is connected to the desk phone.
	Symphonic HD audio is used during conversation.

## Features keys

Mute and interphony.	
Hands-free, handset or headset volume. Adjust the brightness. Adjust contrast.	
Audio services (hands-free, handset or headset). Bluetooth® audiohub application.	
<ul style="list-style-type: none"> <li>Programmable keys (F1 and F2 keys): lit when the function associated with the key is activated. A service or a direct call can be associated to these keys.</li> <li>Pre-programmed function keys are disabled in 'safe ' mode. The F1 and F2 keys are line keys.</li> </ul>	
Redial key: to access the 'Redial' feature. For the phones 8018/8008G/8008 DeskPhone, the redial key is associated with the Off-hook key when the phone is in idle state:	
Quick access to user local menu (long press). Used to obtain information on functions of the 'menu' page and to program key of the 'perso' page (short press). Not available on 8018/8008G/8008 DeskPhone.	
Messaging key to access various mail services. This key is lit when you have received a new voicemail, text message or callback request.	
Hands-free key To make or answer a call without lifting the handset.	
END key To terminate a call.	

## Bluetooth® wireless handset (Compatible Bluetooth® desk phone)

Off-hook/On-hook.	
Volume/Mute: <ul style="list-style-type: none"> <li>Short successive presses to change the handset volume level (3 levels).</li> <li>Long press to ensure your caller no longer hears you.</li> </ul>	

## Welcome screens

- Menu page Contains all functions and applications accessible via the keys associated with the words on the screen.
- Perso page Contains call line keys (allowing supervision of calls) and programmable call keys.
- Info page Contains information on the telephone and the status of its functions: name, telephone number, number of messages, activation of transfer function, appointment reminder, etc.

	Manage your call forwarding by pressing the forward icon. <ul style="list-style-type: none"> <li>Stationary arrow: no forwarding activated.</li> <li>Blinking or rotating arrow according to the skin: forwarding activated.</li> </ul>
--	---

## Touchscreen navigation (8078s/8078s BT Premium DeskPhone)

	Select a page by pressing the corresponding tab on the screen. The selected page is highlighted. Make your selection by pressing the label on the screen. Scroll through a list (features, call log, contact, ...) by pressing the up and down arrow on the screen, or the up-down navigator keys.
	Use the 'OK' softkey to validate your choices and options while programming or configuring.
	Use the 'Back/Exit' icon to go back to the previous step.
	Use the 'setting' icon to quick access to the user local menu.
	Use the 'Bluetooth®' softkey to open Bluetooth® settings.

## Navigation keys

	OK key: use this key to validate your choices and options while programming or configuring.
	Left-right navigator: used to move from one page to another and display information about current calls (call in progress, calls on hold, incoming call).
	Up-down navigator: used to scroll through the content of a page.
	Use this key to go back to the previous step.
	Use this key to go back to the homepage (long press).











## User local menu









Or (long press): Open the user local menu







## Alpha-numeric keyboard (8018/8008G/8008 DeskPhone)

- Switch the keyboard to the alphabetic mode by selecting the associated preprogrammed key. When activated, the LED corresponding to the key remains lit up.
- Enter alphabetic characters. The number pad keys have letters that you can display by successive presses. The number is the last character in the series. Some special characters can be displayed by successively pressing the key:

	%	\$	/	~	&	(	)	[	]	=	*
# key icon"/>	@	#									
	Space		-	_	1						
	+	.	,	;	:	\	?	!	<	>	0

<b>Call</b> Dial the number directly or dial the number after pressing a line key (an off-hook key phone or Bluetooth® handset, hands-free key).	
<b>Call by name (Company directory)</b> Enter the name, contact's surname/name or initials and follow the on-screen instructions.	
<b>Answer a call</b> Take the handset off the hook, use an off-hook key (phone or Bluetooth® handset), use the hands-free key, or press the incoming call icon.	
<b>Ignore the call / End the call.</b>	
<b>Redial</b> Long press to access the list of the last 8 dialed numbers. Short press to call the last dialed number.	
<b>Make a call-back request to a busy number</b> <i>Callback</i>	
<b>Placing a call on hold (hold)</b> <i>Hold</i>	
<b>Sending DTMF signals</b> <i>Send DTMF</i> Send numbers.	
<b>Mute</b>	
<b>Interphony</b> The phone automatically answers the call. Before the line is taken, you hear a succession of specific beeps.	 Long press
<b>Switching between audio modes</b>	
<b>Making a second call during a conversation</b> <i>New call</i>	
<b>Answering a second call during a conversation</b> Select the incoming call icon.	
<b>Switching between calls (Broker call)</b> Select the call on hold icon from the conversation screen.	 
<b>To cancel your second call and recover the first</b> You automatically recover the first call.	

<b>Transferring a call</b> You are in conversation with one contact. Call a second contact. <i>Transfer.</i>	
<b>Conference</b> Call the first contact. Call the second contact. <i>Conference (Confer).</i>	
<b>Make calls via your programmed call keys</b> Press the desired programmed call key.	Perso
<b>Programming direct call keys</b> Press the 'I' key or <i>Settings &gt; Phone &gt; Key program</i> Select the key to program. Enter the name and number to associate to the key.	Menu 
<b>Modify the programmed key</b> Press the 'I' key Or <i>Settings &gt; Phone &gt; Key program</i> Press the programmed key to be modified. Follow the on-screen instructions.	Menu 
<b>Erase a programmed key</b> Press the 'I' key Or <i>Settings &gt; Phone &gt; Key program</i> Select the key to be erased. Follow the on-screen instructions.	Menu 
<b>Customizing your voice greeting</b> <i>Voice mail &gt; Perso options</i> You can listen to the greeting, customize the greeting and set the default greeting.	
<b>Consulting your voice mailbox</b>	
<b>Diverting calls to your voice mailbox</b> Select the forward icon. <i>Imm fwd VM</i> Select the type of call forwarding required.	
<b>Cancel forward</b> Select the forward icon. <i>Deactivate &gt; Deactivate forward</i>	
<b>Do not disturb</b> Select the forward icon. <i>DoNotDisturb (DND)</i>	

<b>Send text messages</b> <i>Message</i> <i>SendTxtMsg</i> Enter the destination number. Select the type of message to send (fixed Msg, New Msg,...).	
<b>Read text messages</b> <i>New text message</i> <i>Read msg</i>	
<b>Information about the phone</b>	Info
<b>Lock/unlock the phone</b> <i>Lock</i>	Menu
<b>Adjust audio volume</b>	 
<b>Select the language of your choice</b> <i>Settings &gt; Phone &gt; Language</i>	Menu
<b>Choose the tune</b> <i>Settings &gt; Phone &gt; Ringing</i> Adjust the ring via the following menus: Melody, Silent, Beeps, Volume, etc.	Menu
<b>Adjust the brightness of the set</b> Press the 'I' key <i>&gt; Display &gt; Brightness</i>	
<b>Adjusting screen contrast (8028s/8018)</b> <i>Settings &gt; Phone &gt; Contrast</i>	Menu
<b>Modify the password for your phone set</b> <i>Settings &gt; Phone &gt; Password</i>	Menu
<b>Homepage</b> <i>Settings &gt; Phone &gt; Homepage</i> Select the default page.	Menu
<b>Bluetooth® audiohub</b> You can connect your mobile phone to your desk phone to use it as a Bluetooth® audiohub. You can use your desk phone (hands-free mode, handset or headset) to make and receive call from your mobile phone. A specific ringing of your desk phone is used when you receive a call from your mobile phone <i>Ringing</i> : define the specific ringing for incoming calls. <i>Call log</i> : consult the call log of your mobile phone. <i>Dialpad</i> : dial numbers on your mobile phone from your desk phone.	 Long press